



EASY
LED

BUBO 2.0

FLOODLIGHT SYSTEM

WWW.EASYLED.FI

BUBO 2.0

BUBO® 2.0 IS VERSATILE

Comprehensive control methods such as DALI-2 and DMX/RDM. RGB-version. Broad selection of optics.

BUBO® 2.0 IS SMART

Lighting control solutions with remote control.

BUBO® 2.0 IS LIGHT

Lighter structure with easier installation and maintenance.

BUBO® 2.0 IS SUITABLE FOR TV

The high-quality, flicker-free light is compatible with broadcasting requirements, which is especially important in sports broadcasting



Compatible with Bubo NEST and Bubo CAVE electrical cabinets.

EASY
LED

Models/versions	High power LED luminaires with three (B3) and two (B2) light units as well as versatile floodlight with one light unit (B1)
Power	up to 1 820 W
Light output	up to 254 000 lm
Efficacy	up to 167 lm/W
Light quality	The LED technology available in the Bubo series meets the strictest TLCI (Television Lighting Consistency Index) requirements for comprehensive high-definition broadcasting with highest quality motion reproduction using flicker-free technology.
Materials	<p>Light engine: Die-cast aluminium chassis with powder coating RAL9006</p> <p>Gear Unit: BG: Die-cast aluminium chassis with powder coating RAL9006, anodized aluminium lids BGS: Extruded aluminum frame with anodizing, corrosion-resistant steel ends BGN: Die-cast aluminium chassis with powder coating RAL9006 BGE: Die-cast aluminium chassis with powder coating RAL7016 BGSE: Die-cast aluminium chassis with powder coating RAL7016</p> <p>Condensation control: Pressure balancing valves</p> <p>Lens cover: Extra clear tempered glass, anti corrosion treated steel frame</p> <p>Mounting components: Hot-galvanized steel, corrosion-proof steel; screws made of Delta corrosion-proof coated stainless steel</p>
Optics	Standard symmetrical optics for area, street, hallway and rotation lighting. Special optics for special requirements
IP and IK class	IP66, IK08
	CE
Operating temperature	Up to -40°C ...+55°C (95% RH), depending on the model
Operating environment	Suitable for both outdoor and indoor
Maintenance-free operating life	Up to 100,000 hours
Control	Standard DALI-2 control (1 - 3 addresses/luminaire) Zhaga connectors and D4i available for selected models DMX-RDM available for selected models 1-10V and 1-10V with a turn-off system available for selected BG and BGS models A selection of smart lighting control solutions CLO can be programmed at the factory Night time dimming (Kaamos) can be programmed at the factory (DALI and D4.1 versions)
Dimming features	Light HDFS flicker-free capability up to <1% index (0,001). Dimmable up to 1%. On the lowest dimming levels PWM (500 Hz or 1200 Hz) possible.

Available colour rendering:		CRI > 70	CRI > 80	CRI > 90
	5700 K		X	o
	5000 K	X	o	
	4000 K	X	X	
	3000 K	o	o	
	2200 K	o		

X = STANDARD
o = OPTION

TLCI	Television Lighting Consistency Index over 90 available
RGB version	RGB version available for both DMX-RDM or DALI controls

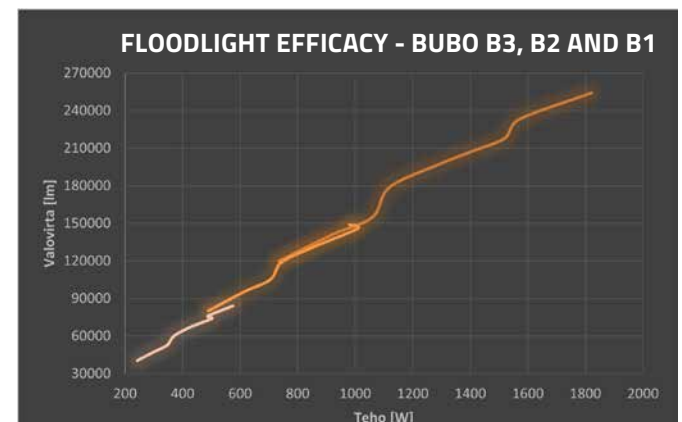

Gear	Model		Voltage (operating area)			
	Luminaire with gear unit	Luminaire separated from gear unit	136LED	120LED D4i	120LED Dali	96LED Dali
BG	B2G	B1 and B2	100–240 VAC (90–305 VAC)	100–240 VAC (90–305 VAC)	-	-
BG	B2G, B3G	B1, B2 and B3	-	-	230 VAC (198–264 VAC)	230 VAC (202–254 VAC)
BGS	B1G	-	100–240 VAC (90–305 VAC)	100–240 VAC (90–305 VAC)	230 VAC (198–264 VAC)	230 VAC (202–254 VAC)
BGN	B3GN	B1, B2 and B3	220–415 VAC (198–457 VAC)	220–415 VAC (198–457 VAC)	220–415 VAC (198–457 VAC)	-
BGE	B3GE, B2GE	B1, B2 and B3	-	-	220–400 VAC (198–440 VAC)	220–400 VAC (198–440 VAC)
BGSE	B1GE	B1	220–480 VAC (198–528 VAC)	-	220–480 VAC (198–528 VAC)	220–480 VAC (198–528 VAC)

BG & BGS (BL120LED DALI, BL96LED DALI) available as emergency lighting (230 VDC)

Operating frequency	50/60 Hz
Power factor (PF)	> 0,95
Protection class	CL I
Electrical connections	BG, BGN, BGE & BGSE: Spring clamp terminals BGS: installation cable
Surge protection	BG ja BGS (BL:136LED, BL:120LED D4i, BL:96LED): L-GND, N-GND 10 kV, L-N 6 kV BG ja BGS (BL:120LED DALI): L-GND, N-GND 6 kV, L-N 4 kV BGN: L-GND, N-GND 10 kV, L-N 10 kV BGE: 10 kV BGSE: L-GND, N-GND 10 kV, L-N 6 kV Available BG (DALI & D4i) & BGS (DALI): 10 kV, 10kV including DALI control line protection (not D4i) or 20 kV protection devices designed especially for floodlights in high installation positions
Inrush control	BG ja BGS (BL:120LED DALI) intelligent as standard. BG ja BGS (BL:136LED, BL:120LED D4i, BL:96LED) standard. BGN, BGE ja BGSE standard.
Intelligent drive current control	BG and BGS (BL120LED) Soft start in cold conditions protects the LED components.
Automatic thermal protection	Mono- or bi-functional protection with smart power limiting function depending on model



Luminous flux for 740 type, depending on optional selected gear. Contact us for light distribution files for the latest values. Defining temperature for performance Tq 25 °C
Given values are nominal values and may vary +/- 10%

BUBO Party

BUBO Party offers a highly saturated color space, ultra stable optics, exceptionally long lifespan and good thermal resistance.

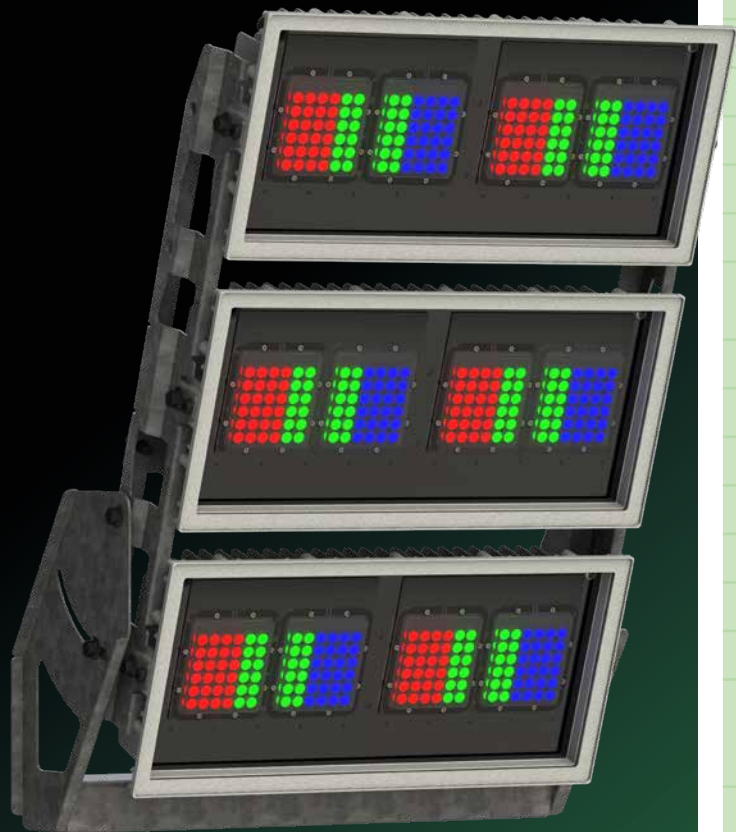

EASY
LED

BUBO PARTY

BUBO PARTY DMX-RDM RGB floodlight offers a highly saturated color space. This is made possible by specially selected LEDs that are connected to a specially designed black circuit board and protected by ultra stable optics and tempered glass. Optimised red, green and blue can be projected in rich hues.

The floodlight is available as a set of three Bubo B1 luminaires controlled by a BGE gear unit. B1 floodlight units can be installed and moved independent of each other. This option enables versatile combinations with B3 and B2 solutions. Mounting options are diverse, and there is a separate floodlight model for installations with lighting aimed above the horizon.

Floodlights are available with multiple symmetric and oval beams, making them suitable for a broad scope of uses. The floodlight is designed for challenging installation conditions and offers exceptional lifespan, dimming control and good thermal resistance. The operation even under harsher conditions is maintained, thanks to the Bubo series IP66 and IK08 frame.

Mains voltage	BGE: 230...400 VAC (operating area: 190 - 440 VAC)
Frequency	50/60 Hz
Power	1290 W (3 * 430 W)
Protection class	CL I
	CE
Electrical connections	Spring clamp terminals
Control	DMX-RDM channel-specific RGB control. Available with DALI-2 or DALI-2 compatible control (1 - 3 addresses/luminaire)
Dimming curves	Linear and logarithmic
Frame	Die-cast aluminium chassis, tempered glass and corrosion-protected steel structures
IP- and IK -classes	IP66, IK08
Light aiming	Downwards from the horizon as standard. Luminaires with upwards facing light also available
Thermal management	Fully passive
Operating temperature	All channels and full power: -40...+35°C, 3 x B1 configuration -40...+30°C 1 x B3 configuration
Luminous flux	3 x B1 configuration 3 x 18 000 lm (x: 0,242 y:0,152), B3 configuration 54 000 lm
Optics	NP-Oval 15°x40° FWHM optics Symmetrical NP-optics 15° - 45° FWHM Clear glass 140° FWHM version
Light unit lifetime L90	All channels and full power: 60 000 h 3 x B1 configuration, 50 000 h 1 x B3 configuration
Flicker-free	HDFE flicker-free light level down to 18% . Dimming down to 1% (1200Hz pwm)

Brackets

B1 & B1G, B1GE

Flood light bracket

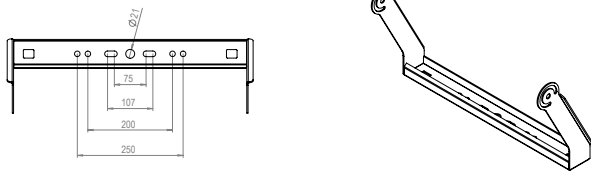

Area bracket

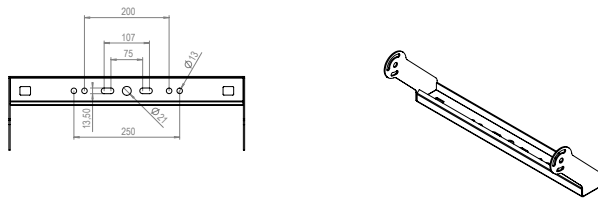

Bracket

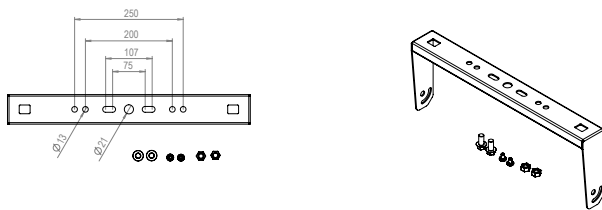

Bracket B1GE

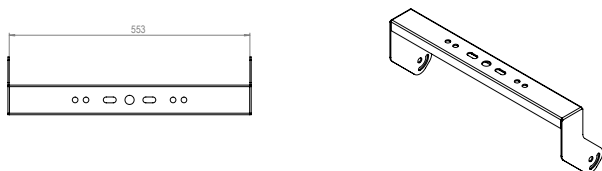

B2 & B2G, B3 & B3G

Area bracket

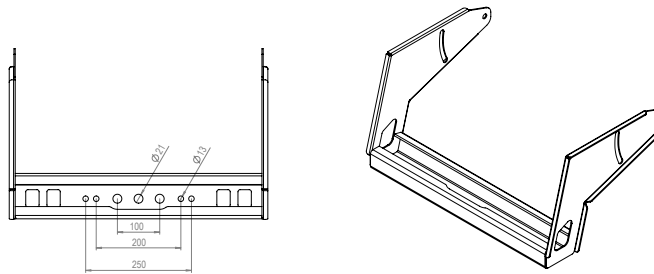

Bracket L

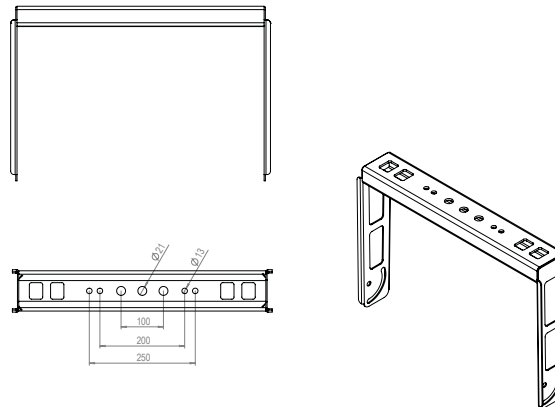

Stadium bracket

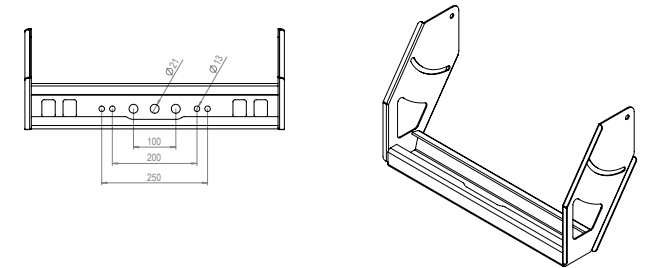

Bracket S

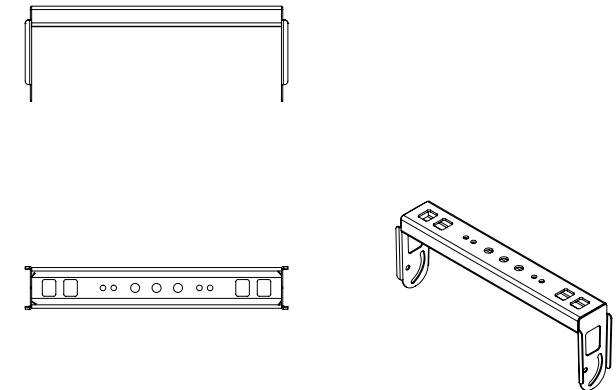

WEIGHT

	Luminaire	Bracket			
	Light engine, rack & gear	Area	Stadion	Pendant L	Pendant S
Bubo B3GN	39	8,2	8,1	6,4	5,6
Bubo B3G - 360LED	40				
Bubo B3G - 288LED	41				
Bubo B2G Zhaga	31	5,0	5,1	4,0	3,6
Bubo B2G - 240LED	29				
Bubo B2G - 192LED	30				
Bubo B2GSE - 240LED	29	5,0	5,1	4,0	3,6
Bubo B2GSE - 192LED	29				
	Light engine and gear	Area	Flood light	Pendant	B1G bracket
Bubo B1G Zhaga	14,1	2,1	2,4	2,0	2,2
Bubo B1G - 120LED	13,1				
Bubo B1G - 96LED	13,5				
Bubo B1GE - 136LED	12,6				
Bubo B1GE - 120LED	12,5				
Bubo B1GE - 96LED	12,3				

EASY LED

	Luminaire	Drivers			
	Light engine and rack	BG	BG ZT	BGN	BGE
Bubo B3 - 408LED	31			7,0	
Bubo B3 - 360LED	31	8,5			
Bubo B3 - 288LED	30	10,5			
Bubo B2 - 272LED	20		9,7		
Bubo B2 - 240LED	20	7,6			
Bubo B2 - 192LED	20	9,0			
	Light engine				BGSE
Bubo B1 - 136LED	9,2				3,1
Bubo B1 - 120LED	9,1				
Bubo B1 - 96LED	9,0				

Weights for standard models. Customer-specific changes can affect the weights.

B3G AREA (BG GEAR)

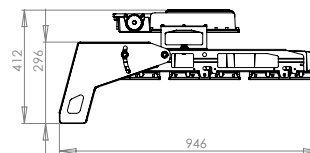
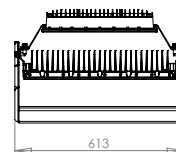
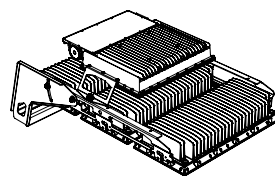

B3GN AREA (BGN GEAR)

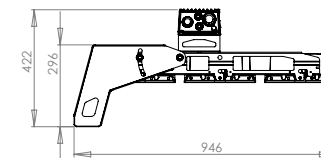
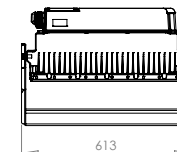
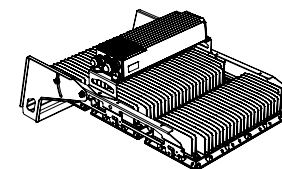

B3G STADIUM (BG GEAR)

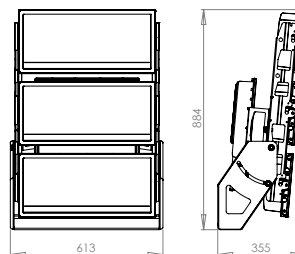
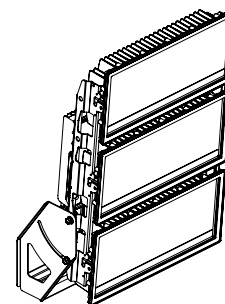

B3GN STADIUM (BGN GEAR)

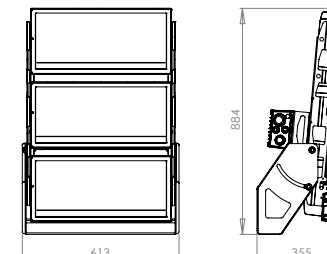
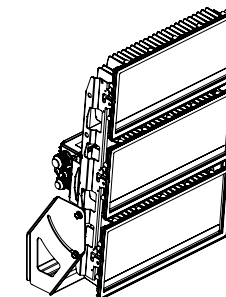

B2G AREA (BG GEAR)

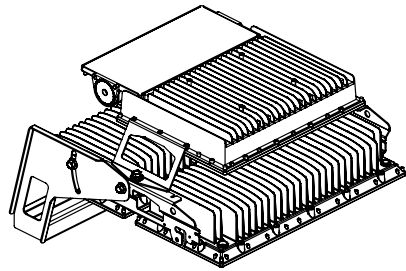
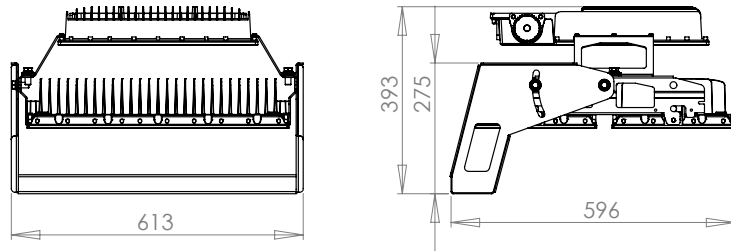

B2G STADIUM (BG GEAR)

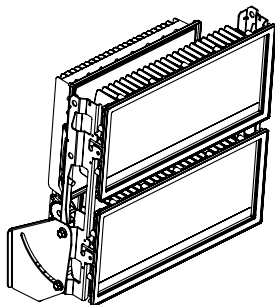
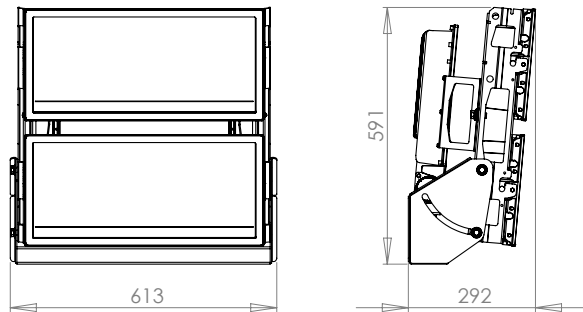

B1G AREA (BGS GEAR)

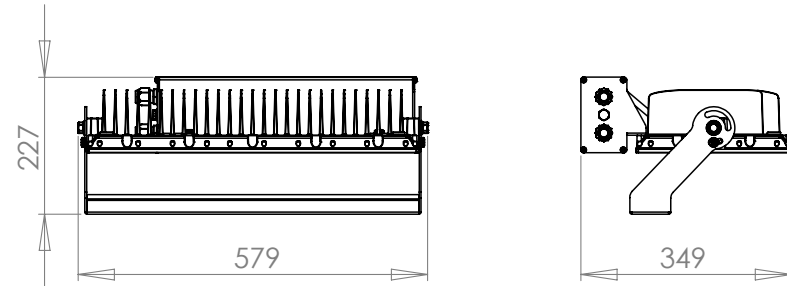

B1GE AREA (BGSE GEAR)

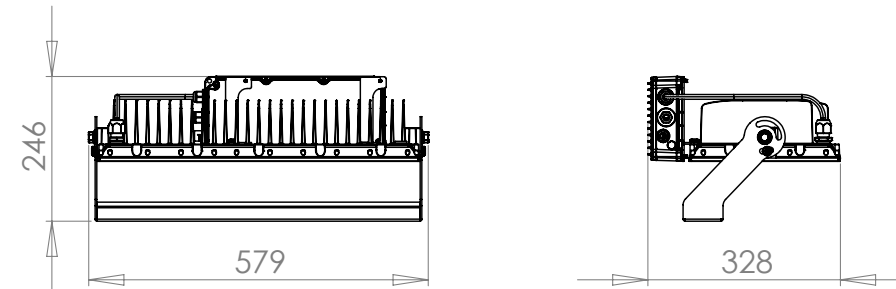

B1 AREA

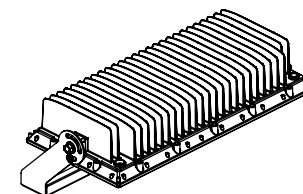
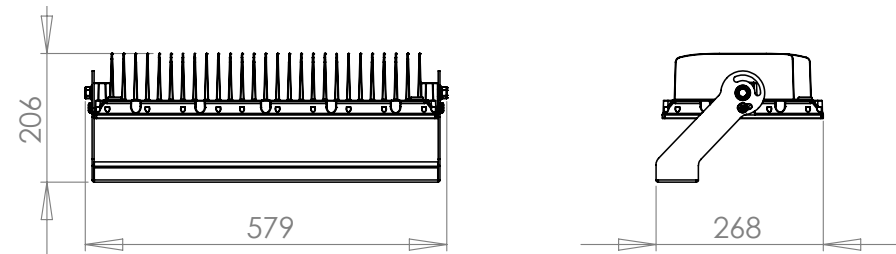



BUBO 2.0 STADIUM

Light engines	B3 (luminaire with separate gear)									B3G or B3GN (with gear unit)																	
Version	408-1500	408-1300	360-1400	360-1300	360-1200	360-1050	288-1200	288-1050	288-850	408-1500	408-1300	360-1400	360-1300	360-1200	360-1050	288-1200	288-1050	288-850									
Max temperature outdoors [°C]	35	35	35	35	40	45	45	50	55	30	30	30	35	35	40	45	45	55									
Max temperature indoors [°C]	25	25	25	30	35	40	40	45	50	20	20	20	25	30	35	40	40	50									
Luminous flux (lm) (740)	254 000	233 000	218 000	207 000	197 000	179 000	155 000	141 000	120 000	254 000	233 000	218 000	207 000	197 000	179 000	155 000	141 000	120 000									
Input power [W]	1 820	1 570	1 520	1 400	1 290	1 120	1 060	920	735	1 820	1 570	1 520	1 400	1 290	1 120	1 060	920	735									
Lumen maintenance																											
100kh	0.88	0.91	0.93	0.95	0.96	0.98	0.96	0.98	0.98	0.88	0.91	0.93	0.95	0.96	0.98	0.96	0.98	0.98									
L90	80 000	>100 000							80 000											>100 000							
Gear unit lifespan (ta 25) [h]	>100 000									100 000									>100 000								
Available (depending on driver selection):																											
DALI addresses	1	1	1 or 3	1 or 3	1 or 3	1 or 3	3	3	3	1	1	1 or 3	1 or 3	1 or 3	1 or 3	3	3	3									
ZD4i addresses	1	1	1	1	1	1	no	no	no	1	1	1	1	1	1	no	no	no									
DMX-RDM addresses	1	1	1-3	1-3	1-3	1-3	no	no	no	1	1	1-3	1-3	1-3	1-3	no	no	no									
BUBO NEST/CAVE	no	no	Yes	Yes	Yes	Yes	no	no	no	-	-	-	-	-	-	-	-	-									
Light minimum level BG			1%	1%	1%	2%	12%	13%	15%			1%	1%	1%	2%	12%	13%	15%									
Light minimum level BGN	1%	1%	1%	1%	1%	1%				1%	1%	1%	1%	1%	1%												

Available optical solutions: Rotationally symmetrical: HP-12, HP-25, HP-50, HP-68, Clear. Corridor optics: SP-C, SP-V. Street optics: e.g. SP-J



BUBO 2.0 STADIUM

Light engines	B2 (luminaire with separate gear)							B2G (with gear unit)						
	272-1200	240-1400	240-1200	240-1050	192-1200	192-1050	192-850	272-1200	240-1400	240-1200	240-1050	192-1200	192-1050	192-850
Version	272-1200	240-1400	240-1200	240-1050	192-1200	192-1050	192-850	272-1200	240-1400	240-1200	240-1050	192-1200	192-1050	192-850
Max temperature outdoors [°C]	35	35	40	45	45	50	55	35	35	40	45	45	50	55
Max temperature indoors [°C]	30	25	35	40	40	45	50	25	25	35	40	40	45	50
Luminous flux (lm) (740)	149 000	146 000	131 000	119 000	105 000	95 000	80 000	149 000	146 000	131 000	119 000	105 000	95 000	80 000
Input power [W]	980	1 010	855	745	705	612	490	980	1 010	855	745	705	612	490
Lumen maintenance														
100kh	0.93	0.93	0.96	0.98	0.96	0.98	0.98	0.93	0.93	0.96	0.98	0.96	0.98	0.98
L90	>100 000							>100 000						
Gear unit lifespan (ta 25) [h]	>100 000							>100 000						
Available (depending on driver selection):														
DALI addresses	no	2	2	2	2	2	2	no	2	2	2	2	2	2
ZD4i addresses	no	no	no	no	no	no	no	2	no	2	2	no	no	no
DMX-RDM addresses	no	1-2	1-2	1-2	no	no	no	no	1-2	1-2	1-2	no	no	no
BUBO NEST/CAVE	no	Yes	Yes	Yes	no	no	no	-	-	-	-	-	-	-
Light minimum level BG		1%	1%	2%	11%	12%	14%		1%	1%	2%	11%	12%	14%
Light minimum level BG D4i	6%		6%	7%				6%		6%	7%			

Available optical solutions: Rotationally symmetrical: HP-12, HP-25, HP-50, HP-68, Clear. Corridor optics: SP-C, SP-V. Street optics: e.g. SP-J



BUBO 2.0 STADIUM

Light engines	B1 (luminaire with separate gear)									B1G or B1GE (with gear unit)							
Version	136-1400	136-1200	120-1400	120-1200	120-1050	96-1200	96-1050	96-850		136-1400	136-1200	120-1400	120-1200	120-1050	96-1200	96-1050	96-850
Max temperature outdoors [°C]	30	35	40	45	45	50	55	55		30	35	40	45	45	45	50	55
Max temperature indoors [°C]	20	30	30	35	40	45	50	55		20	30	30	35	40	40	45	50
Luminous flux (lm) (740)	84 000	76 000	74 000	67 000	60 000	52 600	47 500	40 300		84 000	76 000	74 000	67 000	60 000	52 600	47 500	40 300
Input power [W]	575	488	502	426	370	346	302	242		575	488	502	426	370	346	302	242
Lumen maintenance																	
100kh	0.91	0.93	0.93	0.96	0.98	0.96	0.98	0.98		0.91	0.93	0.93	0.96	0.98	0.96	0.98	0.98
L90	>100 000									>100 000							
Gear unit lifespan (ta 25) [h]	>100 000									>100 000							
Available (depending on driver selection):																	
DALI addresses	1	1	1	1	1	1	1	1		1	1	1	1	1	1	1	1
ZD4i addresses	no	no	no	no	no	no	no	no		no	1	no	1	1	no	no	no
DMX-RDM addresses	no	no	1	1	1	no	no	no		no	no	1	1	1	no	no	no
BUBO NEST/CAVE	no	no	Yes	Yes	Yes	no	no	no		-	-	-	-	-	-	-	-

Light minimum level BGS			1%	1%	1%	10%	11%	13%				1%	1%	1%	10%	11%	13%
Light minimum level BGS D4i		6%		6%	7%					6%		6%	7%				
Light minimum level BGSE	8%	9%	8%	9%	10%	9%	10%	12%		8%	9%	8%	9%	10%	9%	10%	12%

Available optical solutions: Rotationally symmetrical: HP-12, HP-25, HP-50, HP-68, Clear. Corridor optics: SP-C, SP-V. Street optics: e.g. SP-J



BUBO 2.0 AREA

Light engines	B3 (luminaire with separate gear)									B3G or B3GN (with gear unit)									
Version	408-1500	408-1300	360-1400	360-1300	360-1200	360-1050	288-1200	288-1050	288-850	408-1500	408-1300	360-1400	360-1300	360-1200	360-1050	288-1200	288-1050	288-850	
Max temperature outdoors [°C]	35	35	35	35	40	45	45	50	55	30	30	30	35	35	40	40	45	50	
Max temperature indoors [°C]	25	25	25	30	30	35	40	45	50	20	20	20	25	30	35	35	40	45	
Luminous flux (lm) (740)	248 000	228 000	213 000	203 000	192 000	175 000	152 000	138 000	118 000	248 000	228 000	213 000	203 000	192 000	175 000	152 000	138 000	118 000	
Input power [W]	1 820	1 570	1 520	1 400	1 290	1 120	1 060	920	735	1 820	1 570	1 520	1 400	1 290	1 120	1 060	920	735	
Lumen maintenance																			
100kh	0.89	0.92	0.93	0.95	0.96	0.98	0.96	0.98	0.98	0.88	0.91	0.92	0.94	0.96	0.98	0.96	0.98	0.98	
L90	80 000	>100 000								80 000	>100 000								
Gear unit lifespan (ta 25) [h]	>100 000									100 000	>100 000	70 000	100 000	>100 000			75 000	>100 000	
Available (depending on driver selection):																			
DALI addresses	1	1	1 or 3	1 or 3	1 or 3	1 or 3	3	3	3	1	1	1 or 3	1 or 3	1 or 3	1 or 3	3	3	3	
ZD4i addresses	1	1	1	1	1	1	no	no	no	1	1	1	1	1	1	no	no	no	
DMX-RDM addresses	1	1	1-3	1-3	1-3	1-3	no	no	no	1	1	1-3	1-3	1-3	1-3	no	no	no	
BUBO NEST/CAVE	no	no	Yes	Yes	Yes	Yes	no	no	no	-	-	-	-	-	-	-	-	-	
Light minimum level BG			1%	1%	1%	2%	12%	13%	15%			1%	1%	1%	2%	12%	13%	15%	
Light minimum level BGN	1%	1%	1%	1%	1%	1%				1%	1%	1%	1%	1%	1%				

Available optical solutions: Area optics: SP-UP-F, SP-UP-F2, SP-F, SP-A Corridor optics: SP-C, SP-V Rotationally symmetrical: HP-12, HP-25, HP-50, HP-68, Clear Street optics and Indirect indoor lighting for B3 and B2 models always with separate drivers. For indirect lighting with B3, B2, B1 and B1G, see the table for heat limits and lumen depreciation for B3G. 408, 272 or 136 LEDs are not suitable for indirect lighting.



BUBO B2 AREA

Light engines	B2 (luminaire with separate gear)							B2G (with gear unit)						
Version	272-1200	240-1400	240-1200	240-1050	192-1200	192-1050	192-850	272-1200	240-1400	240-1200	240-1050	192-1200	192-1050	192-850
Max temperature outdoors [°C]	35	35	40	45	45	50	55	35	35	40	40	40	45	55
Max temperature indoors [°C]	25	25	35	35	40	45	50	25	25	30	35	35	40	50
Luminous flux (lm) (740)	146 000	142 000	128 000	116 000	102 000	93 000	78 000	146 000	142 000	128 000	116 000	102 000	93 000	78 000
Input power [W]	980	1 010	855	745	705	612	490	980	1 010	855	745	705	612	490
Lumen maintenance														
100kh	0.93	0.93	0.96	0.98	0.96	0.98	0.98	0.92	0.93	0.96	0.98	0.96	0.98	0.98
L90	>100 000							>100 000						
Gear unit lifespan (ta 25) [h]	>100 000							>100 000			90 000	>100 000		
Available (depending on driver selection):														
DALI addresses	no	2	2	2	2	2	2	no	2	2	2	2	2	2
ZD4i addresses	no	no	no	no	no	no	no	2	no	2	2	no	no	no
DMX-RDM addresses	no	1-2	1-2	1-2	no	no	no	no	1-2	1-2	1-2	no	no	no
BUBO NEST/CAVE	no	Yes	Yes	Yes	no	no	no	-	-	-	-	-	-	-
Light minimum level BG		1%	1%	2%	11%	12%	14%		1%	1%	2%	11%	12%	14%
Light minimum level BG D4i	6%		6%	7%				6%		6%	7%			

Available optical solutions: Area optics: SP-UP-F, SP-UP-F2, SP-F, SP-A Corridor optics: SP-C, SP-V Rotationally symmetrical: HP-12, HP-25, HP-50, HP-68, Clear Street optics and Indirect indoor lighting for B3 and B2 models always with separate drivers. For indirect lighting with B3, B2, B1 and B1G, see the table for heat limits and lumen depreciation for B3G. 408, 272 or 136 LEDs are not suitable for indirect lighting.



BUBO 2.0 AREA

Light engines	B1 (luminaire with separate gear)									B1G tai B1GE (with gear unit)							
	136-1400	136-1200	120-1400	120-1200	120-1050	96-1200	96-1050	96-850		136-1400	136-1200	120-1400	120-1200	120-1050	96-1200	96-1050	96-850
Version	136-1400	136-1200	120-1400	120-1200	120-1050	96-1200	96-1050	96-850		136-1400	136-1200	120-1400	120-1200	120-1050	96-1200	96-1050	96-850
Max temperature outdoors [°C]	30	35	35	40	45	45	50	55		30	35	35	40	45	45	50	55
Max temperature indoors [°C]	20	30	25	35	40	40	45	50		20	30	25	30	40	40	45	50
Luminous flux (lm) (740)	82 000	74 000	72 000	65 000	59 000	51 400	46 400	39 400		82 000	74 000	72 000	65 000	59 000	51 400	46 400	39 400
Input power [W]	575	488	502	426	370	346	302	242		575	488	502	426	370	346	302	242
Lumen maintenance																	
100kh	0.91	0.93	0.93	0.96	0.98	0.96	0.98	0.98		0.91	0.93	0.93	0.96	0.98	0.96	0.98	0.98
L90	>100 000									>100 000							
Gear unit lifespan (ta 25) [h]	>100 000									>100 000							
Available (depending on driver selection):																	
DALI addresses	1	1	1	1	1	1	1	1		1	1	1	1	1	1	1	1
ZD4i addresses	no	no	no	no	no	no	no	no		no	1	no	1	1	no	no	no
DMX-RDM addresses	no	no	1	1	1	no	no	no		no	no	1	1	1	no	no	no
BUBO NEST/CAVE	no	no	Yes	Yes	Yes	no	no	no		-	-	-	-	-	-	-	-
Light minimum level BGS			1%	1%	1%	10%	11%	13%				1%	1%	1%	10%	11%	13%
Light minimum level BGS D4i		6%		6%	7%						6%		6%	7%			
Light minimum level BGSE	8%	9%	8%	9%	10%	9%	10%	12%		8%	9%	8%	9%	10%	9%	10%	12%

Available optical solutions: Area optics: SP-UP-F, SP-UP-F2, SP-F, SP-A Corridor optics: SP-C, SP-V Rotationally symmetrical: HP-12, HP-25, HP-50, HP-68, Clear Street optics and Indirect indoor lighting for B3 and B2 models always with separate drivers. For indirect lighting with B3, B2, B1 and B1G, see the table for heat limits and lumen depreciation for B3G. 408, 272 or 136 LEDs are not suitable for indirect lighting.

BUBO - OPTICS

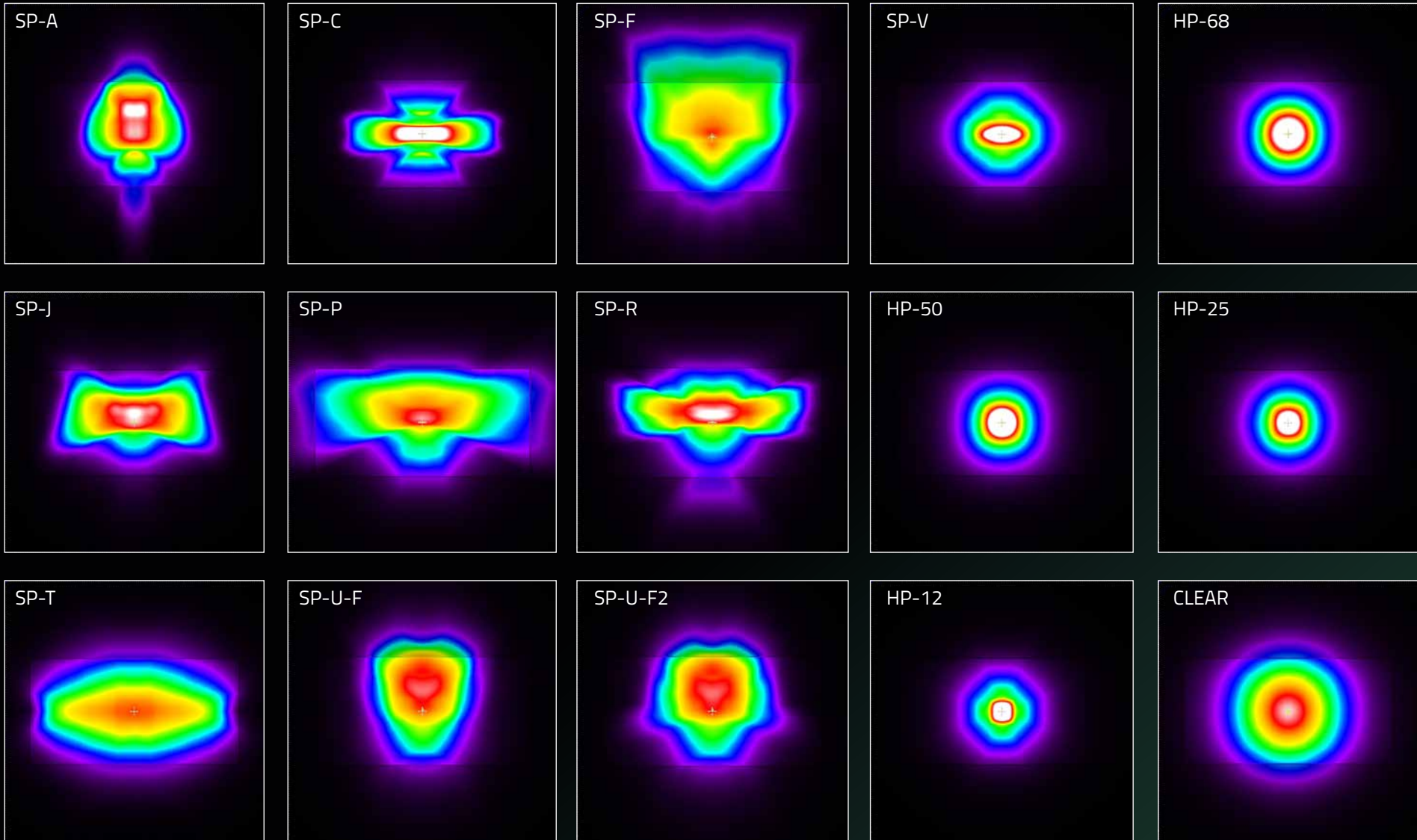

Luminaire at a height of 10 m
 In the middle of rectangle of 80 x 40 m, at an angle of 0 to the ground.

lx



0 2 4 8 16 32 64 128 256 lx

BUBO 2.0 SYSTEMS AND ACCESSORIES

For more information contact:
info@easyled.fi

GEAR UNIT AND CABIN: Bubo Nest ja Bubo Cave



CAVE
BUBO



NEST
BUBO

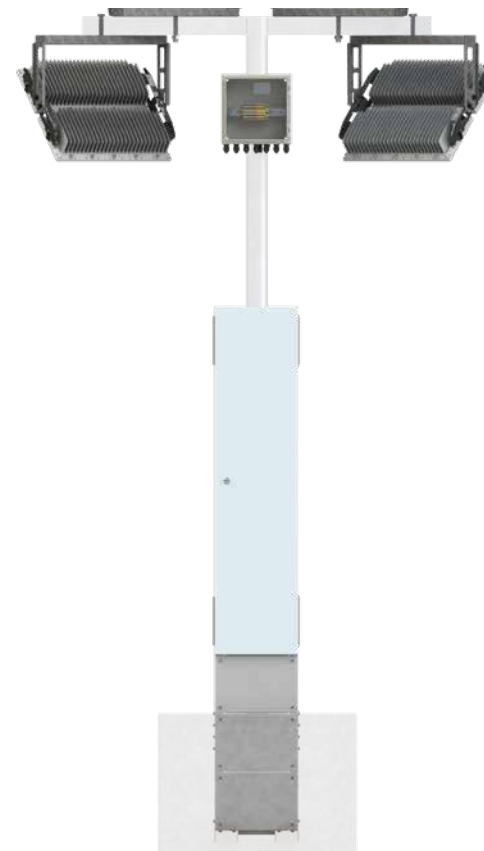

JUNCTION BOXES



ANTI-GLARE VISORS



BIRD SPIKES

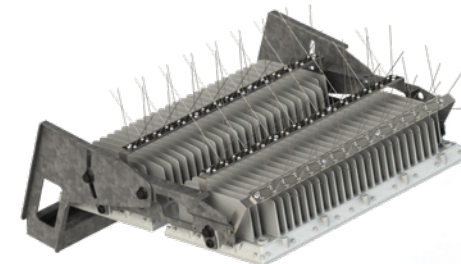



Easy LED Oy
Meriniitynkatu 11
FI-24100 Salo, FINLAND
p. 02 737 44 20

EASY
LED

Investing in high quality LED lighting today will pay off far into the future.
Easy LED Oy is a Finnish company specialized in manufacturing of energy efficient LED lighting systems for different environments, such as sports arenas, industrial premises, roads and areas as well as retail and office spaces.

WWW.EASYLED.FI