

EASY
LED

BUBO 2.0

FLOODLIGHT SYSTEM

WWW.EASYLED.FI

BUBO 2.0

BUBO® 2.0 IS VERSATILE

Comprehensive control methods such as DALI and DMX/RDM. RGB-version. Broad selection of optics.

BUBO® 2.0 IS SMART Alykkäät

Lighting control solutions with remote control.

BUBO® 2.0 IS LIGHT

Lighter structure with easier installation and maintenance.

BUBO® 2.0 IS SUITABLE FOR TV

The high-quality, flicker-free light is compatible with broadcasting requirements, which is especially important in sports broadcasting

Compatible with Bubo NEST and Bubo CAVE electrical cabinets.

EASY
LED



Models/versions	High power LED luminaires with three (B3) and two (B2) light units as well as versatile floodlight with one light unit (B1)
Power	up to 1,520 W
Light output	up to 212,000 lm
Efficacy	up to 160 lm/W
Light quality	The LED technology of the Bubo floodlight system meets the strictest TLCl (Television Lighting Consistency Index) requirements for comprehensive high-definition broadcasting with highest quality motion reproduction using flicker-free technology.
Materials	<p>Light engine: Die-cast aluminium chassis with powder coating RAL9007</p> <p>Gear Unit: Die-cast aluminium chassis with powder coating RAL9006, anodized aluminium lids</p> <p>Condensation control: Pressure balancing valves</p> <p>Lens cover: Extra clear tempered glass, anti corrosion treated steel frame</p> <p>Mounting components: Hot-galvanized steel, corrosion-proof steel; screws made of Delta corrosion-proof coated stainless steel</p>
Optics	Standard symmetrical optics for area, street, hallway and rotation lighting. Special optics for special requirements
IP and IK class	IP66, IK08
Operating temperature	Up to -40°C ...+55°C (95% RH), depending on the model
Operating environment	Suitable for both outdoor and indoor
Maintenance-free operating life	Up to 100,000 hours
Control:	Standard DALI control (1-3 addresses/luminaire), DMX-RDM available for selected models 1-10V and 1-10V with a turn-off system available for selected BG and BGS models A selection of smart lighting control solutions CLO can be programmed at the factory (DALI versions)
Dimming features	Light HDFF flicker-free capability up to <1%. Dimmable up to 2%. On the lowest dimming levels PWM (500 Hz or 1200 Hz) Night-time dimming options can be programmed at the factory (DALI versions)

Available colour rendering:		CRI > 70	CRI > 80	CRI > 90	X = STANDARD o = OPTION
	5700 K		X	o	
	5000 K	X	o		
	4000 K	X	X		
	3000 K	o			
TLCI	Television Lighting Consistency Index over 90 available				
RGB version	RGB version available for both DMX-RDM or DALI controls				

FLOODLIGHT EFFICACY GRAPH

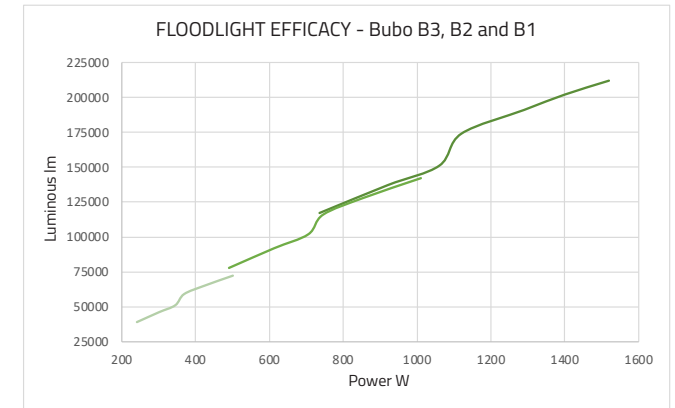

Gear	Model		Voltage (operating area)		
	Luminaire with gear unit	Luminaire separated from gear unit	120 LED lighting units	96 LED lighting units	As emergency lighting
BGS	B1G	-	230VAC (198-264VAC)	230VAC(202-254VAC)	230VDC
BG	B2G, B3G	B1, B2, and B3	230VAC (198-264VAC)	230VAC(202-254VAC)	230VDC
BGE	B2G, B3G	B1, B2, and B3	230...400VAC (190-400VAC)	230...400VAC (190-400VAC)	-

Operating frequency	50/60 Hz
Power factor (PF)	> 0,95
Protection class	CL I
Electrical connections	Spring clamp terminals
Surge protection	BG and BGS (BL:120LED) L-GND, N-GND 6 kV, L-N 4 kV BG and BGS (BL:96LED) L-GND, N-GND 10 kV, L-N 6 kV BGE: 10 kV Available BG & BGS: 10 kV, 10kV including DALI control line protection or 20 kV protection devices designed especially for floodlights in high installation positions
Inrush control	BG and BGS (BL120LED) intelligent as standard, BG and BGS (BL96LED) standard, BGE as standard
Intelligent drive current control	BG and BGS (BL120LED) Soft start in cold conditions protects the LED components.
Automatic thermal protection	Mono- or bi-functional protection with smart power limiting function depending on model



Luminous flux for 740 type, depending on optional selected gear. Contact us for light distribution files for the latest values. Defining temperature for performance Tq 25°C
Given values are nominal values and may vary +/- 10%

BUBO Party

BUBO Party offers a highly saturated color space, ultra stable optics, exceptionally long lifespan and good thermal resistance.



**EASY
LED**

BUBO PARTY

BUBO PARTY DMX-RDM RGB floodlight offers a highly saturated color space. This is made possible by specially selected LEDs that are connected to a specially designed black circuit board and protected by ultra stable optics and tempered glass. Optimised red, green and blue can be projected in rich hues.

The floodlight is available as a set of three Bubo B1 luminaires controlled by a BGE gear unit. B1 floodlight units can be installed and moved independent of each other. This option enables versatile combinations with B3 and B2 solutions. Mounting options are diverse, and there is a separate floodlight model for installations with lighting aimed above the horizon.

Floodlights are available with multiple symmetric and oval beams, making them suitable for a broad scope of uses. The floodlight is designed for challenging installation conditions and offers exceptional lifespan, dimming control and good thermal resistance. The operation even under harsher conditions is maintained, thanks to the Bubo series IP66 and IK08 frame.

Mains voltage	BGE: 230...400 VAC (operating area: 190 - 440 VAC)
Frequency	50/60 Hz
Power	1290 W (3 * 430 W)
Protection class	CL I CE
Electrical connections	Spring clamp terminals
Control	DMX-RDM channel-specific RGB control. Available with a 3 address DALI
Dimming curves	Linear and logarithmic
Frame	Die-cast aluminium chassis, tempered glass and corrosion-protected steel structures
IP- and IK -classes	IP66, IK08
Light aiming	Downwards from the horizon as standard. Luminaires with upwards facing light also available
Thermal management	Fully passive
Operating temperature	All channels and full power: -40...+35°C, 3 x B1 configuration -40...+30°C 1 x B3 configuration
Luminous flux	3 x B1 configuration 3 x 18 000 lm (x: 0,242 y:0,152), B3 configuration 54 000 lm
Optics	NP-Oval 15°x40° FWHM optics Symmetrical NP-optics 15° - 45° FWHM Clear glass 140° FWHM version
Light unit lifetime L90	All channels and full power: 60 000 h 3 x B1 configuration, 50 000 h 1 x B3 configuration
Flicker free	HDFE flicker-free light level down to 18% . Dimming down to 1% (1200Hz pwm)

Brackets

B1 & B1G

Flood light bracket

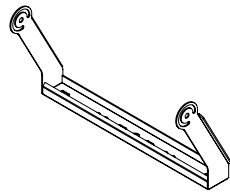
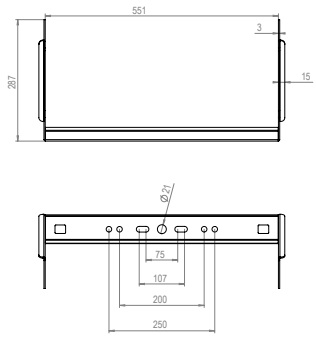

Area bracket

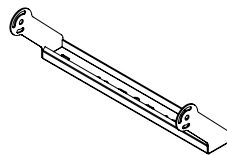
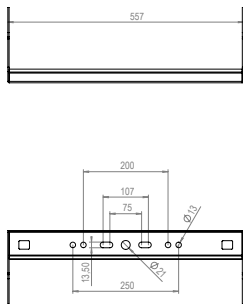

Bracket

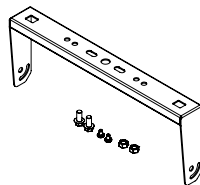
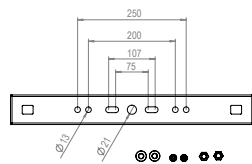

B2 & B2G, B3 & B3G

Area bracket

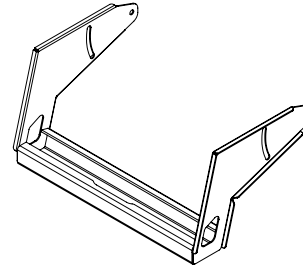
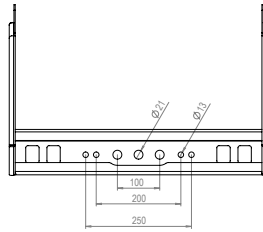

Stadium bracket

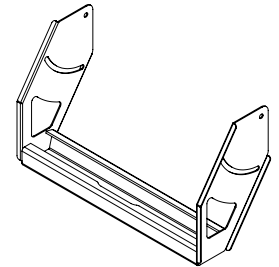
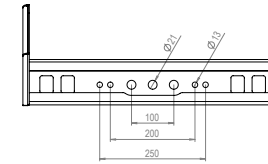

Bracket L

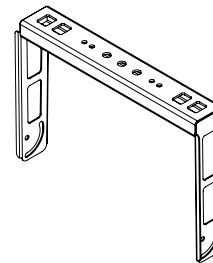
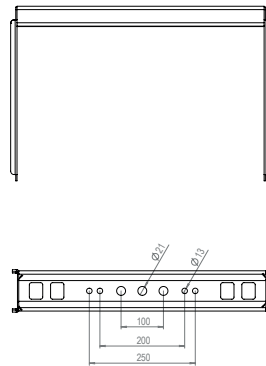

Bracket S

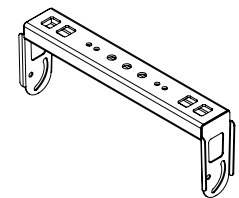
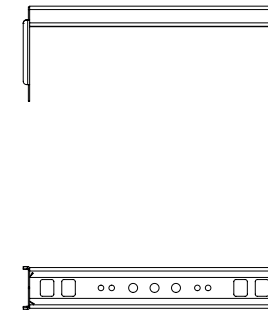

WEIGHT

	Luminaire	Bracket			
	Light engine, rack & gear	Area	Stadium	Pendant L	Pendant S
Bubo B3G - 360LED	40	8,2	8,1	6,4	5,6
Bubo B3G - 288LED	41	8,2	8,1	6,4	5,6
Bubo B2G - 240LED	28	5,0	5,1	4,0	3,6
Bubo B2G - 192LED	29	5,0	5,1	4,0	3,6
	Light engine and gear	Area	Flood light	Pendant	
Bubo B1G - 120LED	13,3	2,0	2,1	2,1	
Bubo B1G - 96LED	13,5	2,0	2,1	2,1	

	Luminaire	Drivers	
	Light engine & rack	BG	BGE
Bubo B3 - 360LED	31	8,5	6,1
Bubo B3 - 288LED	30	10,3	6,1
Bubo B2 - 240LED	20	7,6	5,4
Bubo B2 - 192LED	20	8,8	5,4
	Light engine		
Bubo B1 - 120LED	9,1		
Bubo B1 - 96LED	9,0		

B3G AREA

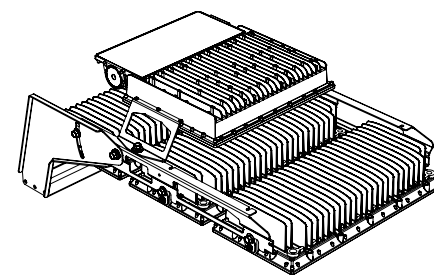
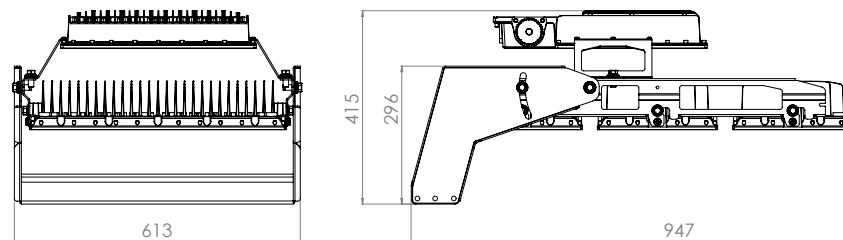

B3G STADIUM

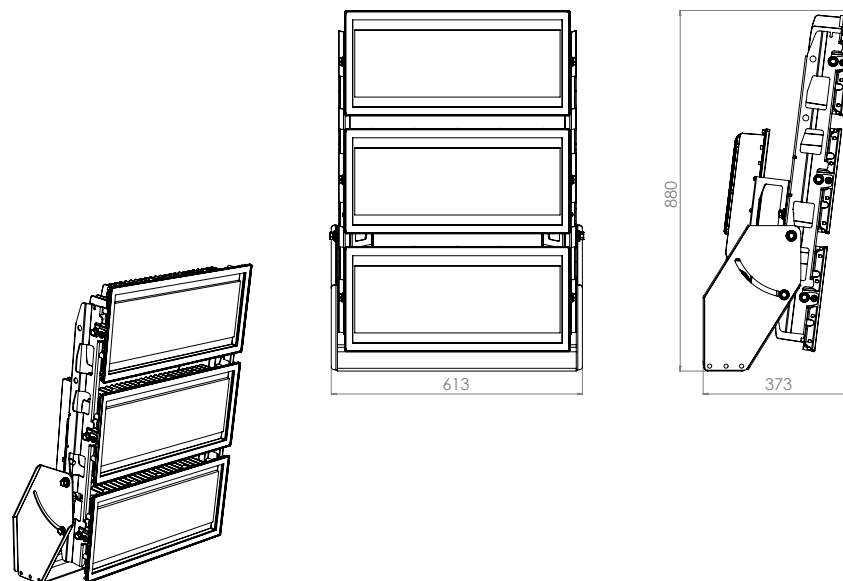

B2G AREA

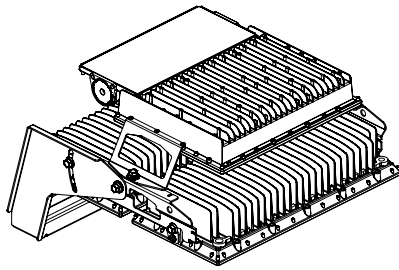
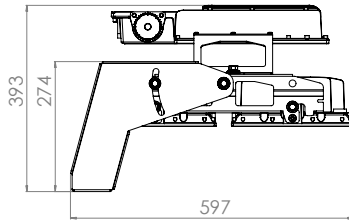
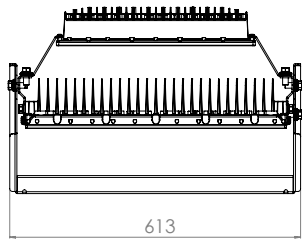

B1G

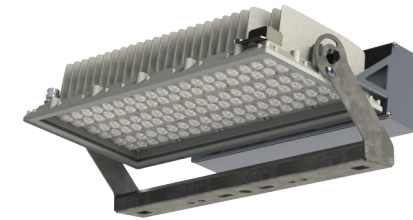
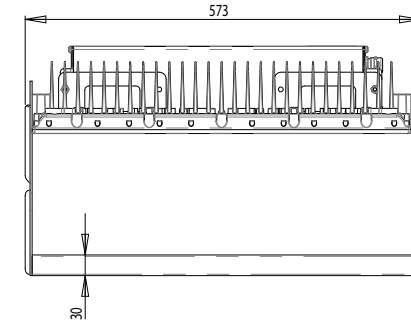
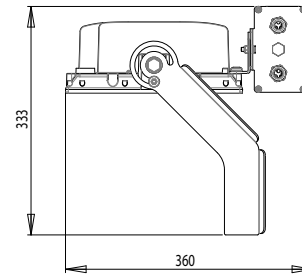

B2G STADIUM

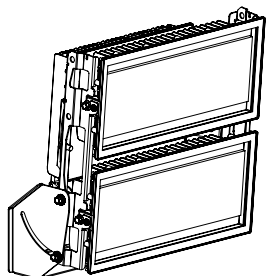
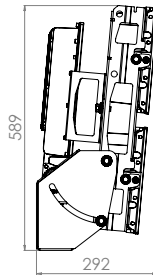
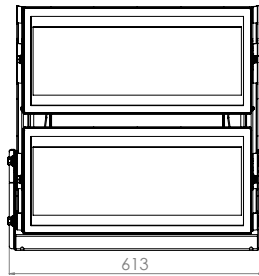

B1

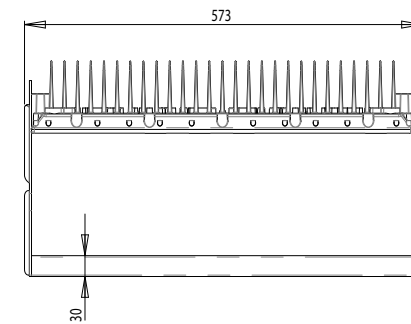
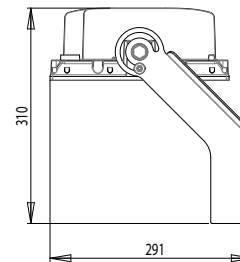



BUBO 2.0 STADIUM

Light engines	B3 (luminaire with separate gear)							B3G (with gear unit)							B2 (luminaire with separate gear)						
Version	360-1400	360-1300	360-1200	360-1050	288-1200	288-1050	288-850	360-1400	360-1300	360-1200	360-1050	288-1200	288-1050	288-850	240-1400	240-1200	240-1050	192-1200	192-1050	192-850	
Max temperature outdoors	35	35	40	45	45	50	55	30	35	35	40	45	45	55	35	40	45	45	50	55	
Max temperature indoors	25	30	35	40	40	45	50	20	25	30	35	40	40	50	25	35	40	40	45	50	
Ta min = -40																					
Luminous flux (lm) (740)	212 000	202 000	191 000	174 000	151 000	137 000	117 000	212 000	202 000	191 000	174 000	151 000	137 000	117 000	142 000	128 000	116 000	102 000	92 000	78 000	
Input power (W)	1520	1400	1290	1120	1060	920	735	1520	1400	1290	1120	1060	920	735	1010	855	745	705	612	490	
Lumen maintenance (CRI70 & CRI80 & CRI90)																					
100kh	0,93	0,95	0,96	0,98	0,96	0,98	0,98	0,93	0,95	0,96	0,98	0,96	0,98	0,98	0,93	0,96	0,98	0,96	0,98	0,98	
L95	70 000	100 000	>100 000					70 000	100 000	>100 000					70 000	>100 000					
L90	>100 000							>100 000							>100 000						
BG(S) gear unit lifespan (indoor)																					
Lifespan [h]	>100 000	>100 000	>100 000	>100 000	>100 000	>100 000	>100 000	>100 000	>100 000	>100 000	>100 000	>100 000	>100 000	>100 000	>100 000	>100 000	>100 000	>100 000	>100 000	>100 000	
BG(S):																					
DALI addresses	3	3	3	3	3	3	3	3	3	3	3	3	3	3	2	2	2	2	2	2	
DMX-RDM available	x	x	x	x				x	x	x	x				x	x	x				
1-10V available	x	x	x	x				x	x	x	x				x	x	x				
Flicker %	<1%	<1%	<1%	<1%	<1%	<1%	<1%	<1%	<1%	<1%	<1%	<1%	<1%	<1%	<1%	<1%	<1%	<1%	<1%	<1%	
Flicker Index	0,001	0,001	0,002	0,002	0,002	0,002	0,002	0,001	0,001	0,002	0,002	0,002	0,002	0,002	0,001	0,002	0,002	0,002	0,002	0,002	
HDFP minimum level	14 %	15 %	16 %	17 %	25 %	28 %	33 %	14 %	15 %	16 %	17 %	25 %	28 %	33 %	14 %	16 %	17 %	25 %	28 %	33 %	
Light minimum level	1 %	1 %	1 %	2 %	12 %	13 %	15 %	1 %	1 %	1 %	2 %	12 %	13 %	15 %	1 %	1 %	2 %	11 %	12 %	14 %	
Power minimum level [W]	19	19	19	19	104	104	104	19	19	19	19	104	104	104	13	13	13	70	70	70	

Clear corridor optics: SP-C, SP-V. Street optics: e.g SP-J
Standard symmetrical optics: HP-12, HP-25, HP-68,



BUBO 2.0 STADIUM

Light engines	B2G (with gear unit)						B1 (luminaire with separate gear)						B1G (with gear unit)						
Version	240-1400	240-1200	240-1050	192-1200	192-1050	192-850	120-1400	120-1200	120-1050	96-1200	96-1050	96-850	120-1400	120-1200	120-1050	96-1200	96-1050	96-850	
Max temperature outdoors	35	40	45	45	50	55	40	45	45	50	55	55	40	45	45	45	50	55	
Max temperature indoors	25	35	40	40	45	50	30	35	40	45	50	55	30	35	40	40	45	50	
Ta min = -40																			
Luminous flux (lm) (740)	142 000	128 000	116 000	102 000	92 000	78 000	72 000	65 000	59 000	51 100	46 200	39 200	72 000	65 000	59 000	51 100	46 200	39 200	
Input power (W)	1010	855	745	705	612	490	502	426	370	346	302	242	502	426	370	346	302	242	
Lumen maintenance (CRI70 & CRI80 & CRI90)																			
100kh	0,93	0,96	0,98	0,96	0,98	0,98	0,93	0,96	0,98	0,96	0,98	0,98	0,93	0,96	0,98	0,96	0,98	0,98	
L95	70 000	>100 000					70 000	>100 000					70 000	>100 000					
L90	>100 000						>100 000						>100 000						
BG(S) gear unit lifespan (indoor)																			
Lifespan [h]	>100 000	>100 000	>100 000	>100 000	>100 000	>100 000	>100 000	>100 000	>100 000	>100 000	>100 000	>100 000	>100 000	>100 000	>100 000	>100 000	>100 000	>100 000	
BG(S):																			
DALI addresses	2	2	2	2	2	2	1	1	1	1	1	1	1	1	1	1	1	1	
DMX-RDM available	x	x	x																
1-10V available	x	x	x				x	x	x				x	x	x				
Flicker %	<1%	<1%	<1%	<1%	<1%	<1%	<1%	<1%	<1%	<1%	<1%	<1%	<1%	<1%	<1%	<1%	<1%	<1%	
Flicker Index	0,001	0,002	0,002	0,002	0,002	0,002	0,001	0,002	0,002	0,002	0,002	0,002	0,001	0,002	0,002	0,002	0,002	0,002	
HDFP minimum level	14 %	16 %	17 %	25 %	28 %	33 %	14 %	16 %	17 %	24 %	27 %	32 %	14 %	16 %	17 %	24 %	27 %	32 %	
Light minimum level	1 %	1 %	2 %	11 %	12 %	14 %	1 %	1 %	1 %	10 %	11 %	13 %	1 %	1 %	1 %	10 %	11 %	13 %	
Power minimum level [W]	13	13	13	70	70	70	6	6	6	34	34	34	6	6	6	34	34	34	



BUBO 2.0 AREA

Light engines	B3 (luminaire with separate gear)							B3G (lwith gear unit)							B2 (luminaire with separate gear)					
Version	360-1400	360-1300	360-1200	360-1050	288-1200	288-1050	288-850	360-1400	360-1300	360-1200	360-1050	288-1200	288-1050	288-850	240-1400	240-1200	240-1050	192-1200	192-1050	192-850
Max temperature outdoors	35	35	40	45	45	50	55	30	35	35	40	40	45	50	35	40	45	45	50	55
Max temperature indoors	25	30	30	35	40	45	50	20	25	30	35	35	40	45	25	35	35	40	45	50
Ta min = -40																				
Luminous flux (lm) (740)	207000	197000	187000	170000	148000	134000	114000	207000	197000	187000	170000	148000	134000	114000	138000	125000	113000	99000	90000	76000
Input power (W)	1520	1400	1290	1120	1060	920	735	1520	1400	1290	1120	1060	920	735	1010	855	745	705	612	490
Lumen maintenance (CRI70 & CRI80 & CRI90)																				
100kh	0,93	0,95	0,96	0,98	0,96	0,98	0,98	0,92	0,94	0,96	0,98	0,96	0,98	0,98	0,93	0,96	0,98	0,96	0,98	0,98
L95	70 000	100 000	>100 000					65 000	85 000	>100 000					70 000	>100 000				
L90	>100 000						>100 000						>100 000							
BG(S) gear unit lifespan (indoor)																				
Lifespan [h]	>100 000	>100 000	>100 000	>100 000	>100 000	>100 000	>100 000	>100 000	>100 000	>100 000	>100 000	>100 000	>100 000	>100 000	>100 000	>100 000	>100 000	>100 000	>100 000	>100 000
BG(S):																				
DALI addresses	3	3	3	3	3	3	3	3	3	3	3	3	3	3	2	2	2	2	2	2
DMX-RDM available	x	x	x	x				x	x	x	x				x	x	x			
1-10V available	x	x	x	x				x	x	x	x				x	x	x			
Flicker %	<1%	<1%	<1%	<1%	<1%	<1%	<1%	<1%	<1%	<1%	<1%	<1%	<1%	<1%	<1%	<1%	<1%	<1%	<1%	<1%
Flicker Index	0,001	0,001	0,002	0,002	0,002	0,002	0,002	0,001	0,001	0,002	0,002	0,002	0,002	0,002	0,001	0,002	0,002	0,002	0,002	0,002
HDFD minimum level	14 %	15 %	16 %	17 %	25 %	28 %	33 %	14 %	15 %	16 %	17 %	25 %	28 %	33 %	14 %	16 %	17 %	25 %	28 %	33 %
Light minimum level	1 %	1 %	1 %	2 %	12 %	13 %	15 %	1 %	1 %	1 %	2 %	12 %	13 %	15 %	1 %	1 %	2 %	11 %	12 %	14 %
Power minimum level [W]	19	19	19	19	104	104	104	19	19	19	19	104	104	104	13	13	13	70	70	70

Area optics: SP-UP-F, SP-F, SP-A. Corridor optics: : SP-C, SP-V. Rotationally symmetrical: HP-12, HP-25, HP-50, HP-68, Clear. Street optics. Indirect indoor lighting always with separate drivers. B3 and B2 thermal limits and luminous flux lifespan according to B3G values.

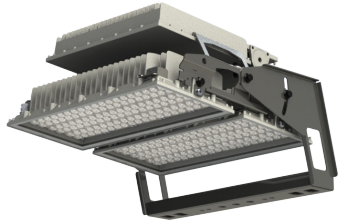

BUBO 2.0 AREA

Light engines	B2G (with gear unit)						B1 (luminaire with separate gear)						B1G (with gear unit)						
Version	240-1400	240-1200	240-1050	192-1200	192-1050	192-850	120-1400	120-1200	120-1050	96-1200	96-1050	96-850	120-1400	120-1200	120-1050	96-1200	96-1050	96-850	
Max temperature outdoors	35	40	40	40	45	55	35	40	45	45	50	55	35	40	45	45	50	55	
Max temperature indoors	25	30	35	35	40	50	25	35	40	40	45	50	25	30	40	40	45	50	
Ta min = -40																			
Luminous flux (lm) (740)	138000	125000	113000	99000	90000	76000	70000	63000	57000	50000	45200	38300	70000	63000	57000	50000	45200	38300	
Input power (W)	1010	855	745	705	612	490	502	426	370	346	302	242	502	426	370	346	302	242	
Lumen maintenance (CRI70 & CRI80 & CRI90)																			
100kh	0,93	0,96	0,98	0,96	0,98	0,98	0,93	0,96	0,98	0,96	0,98	0,98	0,93	0,96	0,98	0,96	0,98	0,98	
L95	70 000	>100 000					70 000	>100 000					70 000	>100 000					
L90	>100 000						>100 000						>100 000						
BG(S) gear unit lifespan (indoor)																			
Lifespan [h]	>100 000	>100 000	>100 000	>100 000	>100 000	>100 000	>100 000	>100 000	>100 000	>100 000	>100 000	>100 000	>100 000	>100 000	>100 000	>100 000	>100 000	>100 000	
BG(S):																			
DALI addresses	2	2	2	2	2	2	1	1	1	1	1	1	1	1	1	1	1	1	
DMX-RDM available	x	x	x																
1-10V available	x	x	x				x	x	x				x	x	x				
Flicker %	<1%	<1%	<1%	<1%	<1%	<1%	<1%	<1%	<1%	<1%	<1%	<1%	<1%	<1%	<1%	<1%	<1%	<1%	
Flicker Index	0,001	0,002	0,002	0,002	0,002	0,002	0,001	0,002	0,002	0,002	0,002	0,002	0,001	0,002	0,002	0,002	0,002	0,002	
HDFP minimum level	14 %	16 %	17 %	25 %	28 %	33 %	14 %	16 %	17 %	24 %	27 %	32 %	14 %	16 %	17 %	24 %	27 %	32 %	
Light minimum level	1 %	1 %	2 %	11 %	12 %	14 %	1 %	1 %	1 %	10 %	11 %	13 %	1 %	1 %	1 %	10 %	11 %	13 %	
Power minimum level [W]	13	13	13	70	70	70	6	6	6	34	34	34	6	6	6	34	34	34	



Easy LED Oy
Meriniitynkatu 11
FI-24100 Salo, FINLAND
tel. +358 2 737 44 20

EASY
LED

Investing in high quality LED lighting today will pay off far into the future.
Easy LED Oy is a Finnish company specialized in manufacturing of energy efficient LED lighting systems for different environments, such as sports arenas, industrial premises, roads and areas as well as retail and office spaces.

WWW.EASYLED.FI