

TECHNICAL INFORMATION



STREET AND AREA LIGHTING

PRO FLOW®

The energy saving and cost effective PRO Flow LED luminaires are designed to meet the newest regulations in street and area lighting. The pure Scandinavian design and a range of power options of the luminaire make it suitable for all kinds of environments from streets to parking lots and parks.





PRO FLOW

PRO Flow is smart: The streamlined and compact PRO Flow suits all kinds of environments. The clean Scandinavian design stays fresh through the whole lifespan of the luminaire.

PRO Flow is cost effective: Assembled in a die casting aluminium body, the PRO Flow will endure for years to come. The luminaire requires very little maintenance and its components are easy to replace.

PRO Flow creates safety: The familiar Easy LED road and area lighting optics are known for their efficiency and the extra bright lens cover is hardened. This makes the PRO Flow suitable for all kinds of environments.

- A brand new Easy LED luminaire with all the familiar characteristics, like DALI control.
- A versatile smart luminaire, ready for with wireless control or customisable driver. The revised Kaamos dimmer has even more options than before.
- Upgradeable and easy to maintain. PRO Flow's construction is future proof and it has an automatic maintenance switch for safety.
- Durable. The surface texture of the casing and the self-cleaning cooling system guarantee an exceptional performance level.

- IK09 and IP66 certified.
- Easy to install and adjust. The automatic power switch and body that stays open provide safer maintenance. The integrated mounting angle allows light adjustment after installation.
- Designed and manufactured in Finland.
- Energy efficient. The PRO Flow has a lifespan of over 30 years and needs only a little maintenance.

TECHNICAL DATA

Body:	Aluminium
Lens cover:	Extra bright hardened glass
Coating:	Blasted textured aluminium grey body. Available in powder-coated and in all RAL colours. Painted cooling fins on the efficient L-models.
Optics:	Easy LED road and area optics SP-optics: 94, 80, 64, 48, 40, 32, 24 or 12 LEDs UP-optics: 60, 44, 30 or 14 LEDs
IP-class	IP66
IK-class	IK09
Temperature range	Designed for operating temperatures of -40°C ... +55°C (95 % RH) depending on model.
Control	Built-in DALI. Compatible with third party control systems. CLO lumen maintenance compensation and several intelligent control systems available. Luminaires are available with Zhaga or NEMA compliant connectors.
Input voltage:	230 VAC (operation range: 170 ... 264 VAC)
Input frequency:	50 ... 60 Hz
Power factor (PF):	S-models >22 W: >0,95, input power <22 W: >0,9 M & L models >0,95, Z models >0,9
Inrush current control:	S-, M- ja L -models: 10 kV L-GND, N-GND (EN 61000-4-5), 6 kV L-N (EN 61547) Z-models: 10 kV L-GND, N-GND (EN 61000-4-5), 6 kV L-N (EN 61000-4-5) Z S12-models: 8 kV L-GND, N-GND (EN 61000-4-5), 6 kV L-N (EN 61000-4-5)
Automatic thermal protection:	Built-in 2-stage protection with advanced hysteresis
Luminaire protection class:	I, II available
Installation:	Vertical and horizontal arm 60 - 34mm as standard Adjustable in 5-degree steps.
Weight	S-models: 5,7 kg (Z: 6,1 kg) M-models: 6,5 kg L-models: 13,7 kg
Delivery:	Fully assembled
Guarantee:	5 years
Accessories:	Pre-assembled installation cable, retrofitted light visors, optional internal surge protection device for improved overvoltage and lightning protection, alternative fittings

ADJUSTMENT RANGE (ALL MODELS)

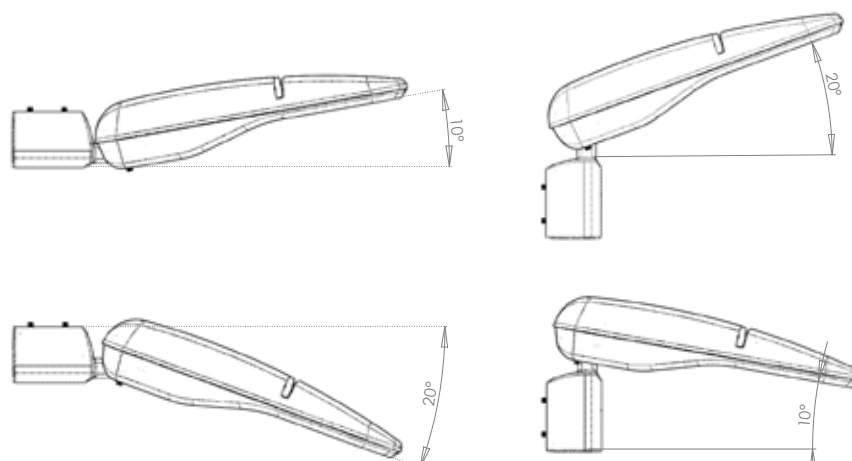

PRO Flow S



Model	12-350	12-420	12-500	12-600	12-700	12-850	12-1000
LEDs	12 pcs.						
DALI addresses	1						
Input power [W]	14 W	16 W	19 W	23 W	26 W	32 W	38 W
Luminous flux [lm]	1830 lm	2150 lm	2520 lm	2960 lm	3380 lm	3980 lm	4550 lm

Model	14-350	14-420	14-500	14-600	14-700	14-850	14-1000
LEDs	14 pcs.						
DALI addresses	1						
Input power [W]	16 W	19 W	22 W	26 W	31 W	37 W	44 W
Luminous flux [lm]	2130 lm	2510 lm	2930 lm	3450 lm	3940 lm	4630 lm	5280 lm
LED unit lumen maintenance L90B10, C10: L80B10, C10:	>200 000						170 000
Temperature range [°C]	-40...+50 °C		-40...+45 °C			-40...+40 °C	

LED unit lumen maintenance L90B10, C10:
L80B10, C10:

Model	24-350	24-420	24-500	24-600	24-700	24-850	24-1000
LEDs	24 pcs.						
DALI addresses	1						
Input power [W]	26 W	31 W	37 W	44 W	52 W	63 W	74 W
Luminous flux [lm]	3650 lm	4300 lm	5020 lm	5870 lm	6690 lm	7820 lm	8880 lm

LED unit lumen maintenance L90B10, C10:
L80B10, C10:

Model	30-350	30-420	30-500	30-600	30-700	30-850	30-1000
LEDs	30 pcs.						
DALI addresses	1						
Input power [W]	32 W	38 W	45 W	54 W	63 W	76 W	90 W
Luminous flux [lm]	4440 lm	5250 lm	6120 lm	7160 lm	8140 lm	9540 lm	10730 lm
LED unit lumen maintenance L90B10, C10: L80B10, C10:	>200 000		>180 000		>150 000	>80 000	>50 000
Temperature range [°C]	-40...+55 °C		-40...+50 °C		-40...+45 °C	-40...+40 °C	-40...+30 °C

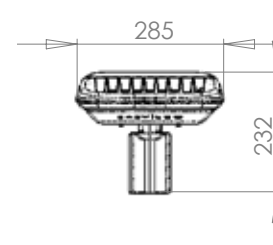
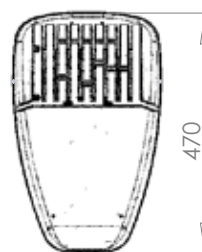
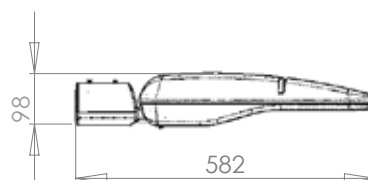

		Standard	
CCT (nominal)	3000 K	4000 K	5000 K
CRI (typical)			
Luminaire luminous efficacy typical*	136 lm/W	147 lm/W	146 lm/W

* For latest values, ask for light distribution files.

PRO Flow M



Model	32-350	32-500	32-600	32-700	32-850	32-1000
LEDs	32 pcs.					
DALI addresses	1					
Input power [W]	34 W	48 W	57 W	67 W	81 W	96 W
Luminous flux [lm]	4480 lm	6160 lm	7190 lm	8280 lm	9660 lm	10890 lm
LED unit lumen maintenance	>150 000 h					
L90B10, C10:	>150 000 h					
L80B10, C10:	>150 000 h					
Temperature range [°C]	-40°C...+50°C		-40°C...+45°C	-40°C...+40°C	-40°C...+35°C	

Model	40-350	40-500	40-600	40-700	40-850	40-1000	40-1050
LEDs	40 pcs.						
DALI addresses	1						
Input power [W]	42 W	59 W	71 W	83 W	101 W	120 W	126 W
Luminous flux [lm]	5570 lm	7660 lm	8940 lm	10140 lm	11890 lm	13430 lm	13880 lm
LED unit lumen maintenance	>150 000 h						
L90B10, C10:	>150 000 h						
L80B10, C10:	>150 000 h						
Temperature range [°C]	-40°C...+50°C	-40°C...+45°C	-40°C...+40°C	-40°C...+35°C	-40°C...+30°C	-40°C...+25°C	

		Standard	
CCT (nominal)	3000 K	4000 K	5000 K
CRI (typical)	72		
Luminaire luminous efficacy typical*	129lm/W	140 lm/W	139 lm/W

* For latest values, ask for light distribution files.

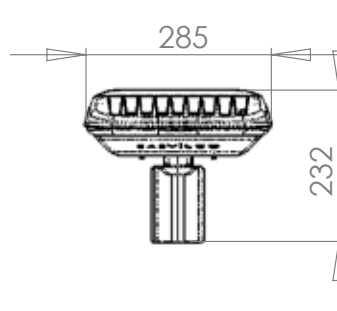
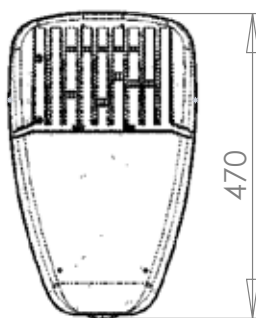
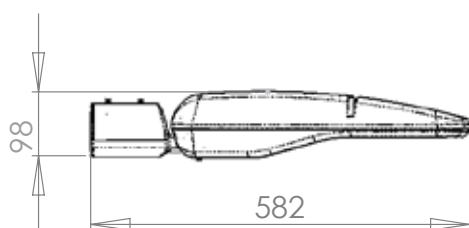

PRO Flow L



LED unit lumen maintenance L90B10, C10:

Model	44-350	44-500	44-600	44-700	44-850	44-1050
LEDs	44					
DALI addresses	1					
Input power [W]	47 W	66 W	79 W	92 W	113 W	141 W
Luminous flux [lm]	6870 lm	9480 lm	11110 lm	12640 lm	14950 lm	17670 lm
LED unit lumen maintenance L90B10, C10:	>150 000 h					130 000 h
L80B10, C10:	>150 000 h					
Temperature range [°C]	-40°C ...+50°C			-40°C ...+45°C		-40°C ...+40°C

LED unit lumen maintenance L90B10, C10:

Model	48-350	48-500	48-600	48-700	48-850	48-1050
LEDs	48					
DALI addresses	1					
Input power [W]	51 W	72 W	86 W	101 W	123 W	153 W
Luminous flux [lm]	7270 lm	10110 lm	11820 lm	13530 lm	15860 lm	18700 lm
LED unit lumen maintenance L90B10, C10:	>150 000 h					
L80B10, C10:	>150 000 h					
Temperature range [°C]	-40°C ...+50°C			-40°C ...+45°C		-40°C ...+40°C

LED unit lumen maintenance L90B10, C10:

Model	60-350	60-500	60-600	60-700	60-850	60-1050
LEDs	60					
DALI addresses	1					
Input power [W]	63 W	89 W	107 W	125 W	152 W	191 W
Luminous flux [lm]	9180 lm	12730 lm	15000 lm	17090 lm	19960 lm	23420 lm
LED unit lumen maintenance L90B10, C10:	>150 000 h					100 000 h
L80B10, C10:	>150 000 h					
Temperature range [°C]	-40°C ...+50°C		-40°C ...+45°C		-40°C ...+40°C	

LED unit lumen maintenance L90B10, C10:

Model	64-350	64-500	64-600	64-700	64-850	64-1050
LEDs	64					
DALI addresses	1					2
Input power [W]	67 W	95 W	114 W	133 W	162 W	201 W
Luminous flux [lm]	9700 lm	13420 lm	15770 lm	17960 lm	21030 lm	24430 lm
LED unit lumen maintenance L90B10, C10:	>150 000 h					130 000 h
L80B10, C10:	>150 000 h					
Temperature range [°C]	-40°C ...+50°C		-40°C ...+45°C		-40°C ...+40°C	-40°C ...+35°C

PRO Flow L

Model	80-350	80-500	80-600	80-700	80-850	80-1050
LEDs	80					
DALI addresses	1			2		
Input power [W]	83 W	118 W	141 W	166 W	204 W	252 W
Luminous flux [lm]	12270 lm	16850 lm	19670lm	22330 lm	26100 lm	30770 lm
LED unit lumen maintenance L90B10, C10: L80B10, C10:	>150 000 h					120 000 h
Temperature range [°C]	-40°C ...+50°C	-40°C ...+45°C		-40°C ...+40°C	-40°C ...+35°C	

Model	96-350	96-500	96-600	96-700	96-850	96-920	96-1000
LEDs	96						
DALI addresses	1			2			
Input power [W]	99 W	141 W	168 W	200 W	242 W	263 W	284 W
Luminous flux [lm]	14680 lm	20120 lm	23330 lm	26730 lm	31250 lm	33190 lm	34940 lm
LED unit lumen maintenance L90B10, C10: L80B10, C10:	>150 000 h					120 000 h	100 000h
Temperature range [°C]	-40°C ...+50°C	-40°C ...+45°C	-40°C ...+40°C	-40°C ...+35°C		-40...+30	

	Vakio		
CCT (nominal)	3000 K	4000 K	5000 K
CRI (typical)	72		
Luminaire luminous efficacy typical*	142 lm/W	154 lm/W	153 lm/W

* For latest values, ask for light distribution files.

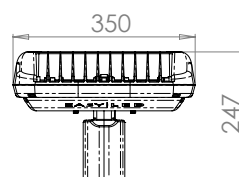
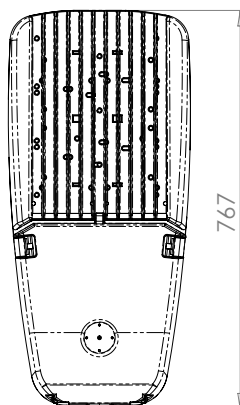
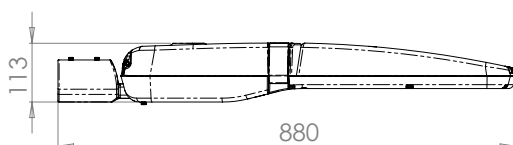

PRO Flow S optics tool

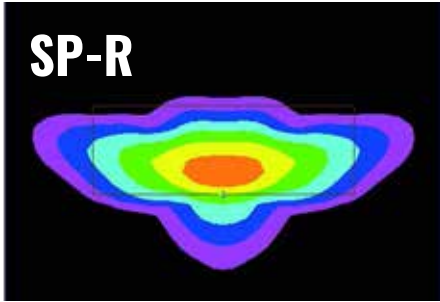

SP-R
Optics for very narrow roads with normal pole spacing. Highly energy efficient.

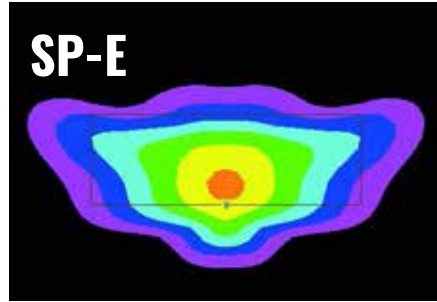

SP-E
For wide roads and long pole spacing. Offers also some back area light.

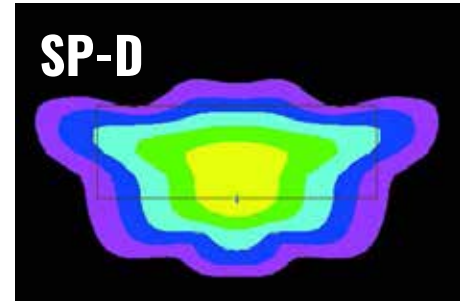

SP-D
As SP-E but offers a lot of back area light.

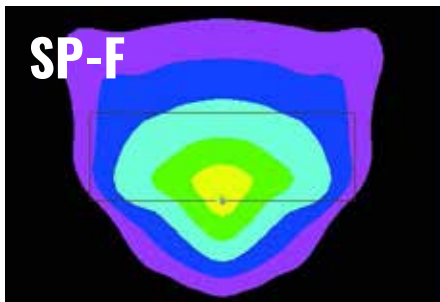

SP-F
Area light for example for parking lots, efficient light from relatively low poles to a wide area.

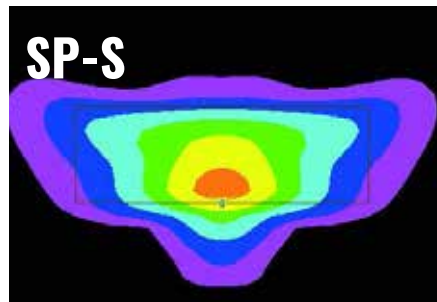

SP-S
Optics for relatively wide roads and for relatively long pole spacing, no back area light.

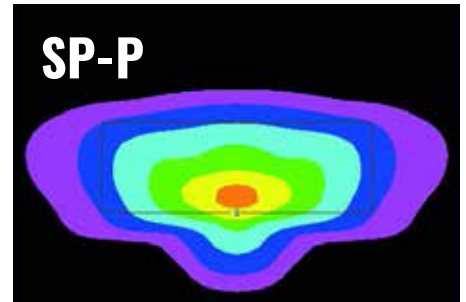

SP-P
General optics for suburban roads, very long pole spacing, even light in wet conditions if far from road, also suitable for relatively wide roads, cycleways and exercise paths.

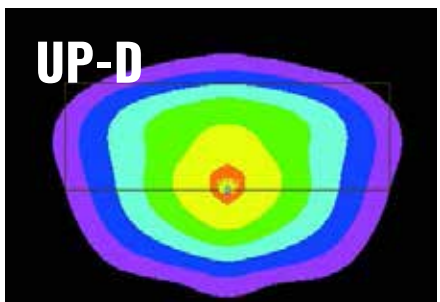

UP-D
Road/area optics for short pole spacing. Offers a lot of back area light.

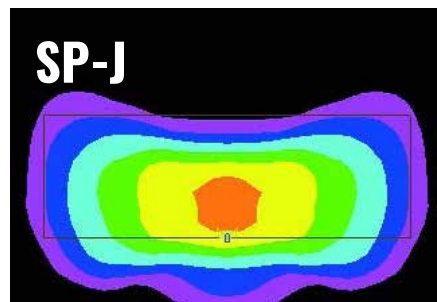

SP-J
Road/area optics for short pole spacing. Offers no back area light.

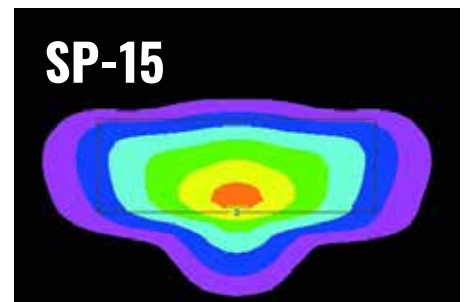

SP-15
General optics for roads with very long pole spacing. Offers even light also in wet conditions. Relatively wide road profile (lits also opposite cycleways if the pole spacing is short)

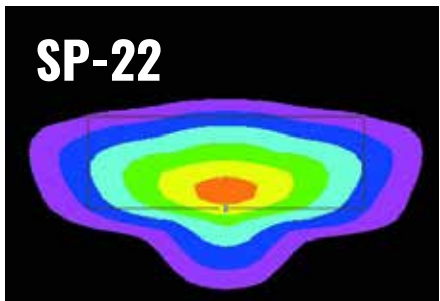

SP-22
Very long pole spacing, offers even light in wet conditions. Energy efficient. Suitable also for cycleways and exercise paths

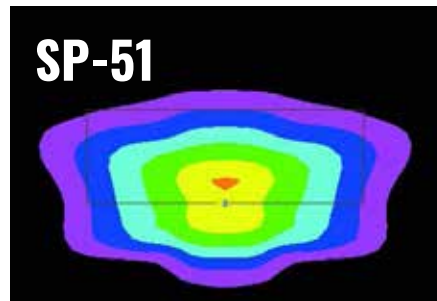

SP-51
A lot of back area light optic for long pole spacing. Energy efficient if cycleways is located behind the poles

ILLUMINANCE (IN LUX, LX)

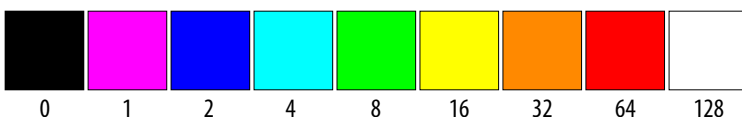

All light patterns depict lights installed at 6 m height and 5° degree angle. Light output 5000 lm. In light patterns the lights are placed at the edge of a 30x10 m square.

PRO Flow L optics tool

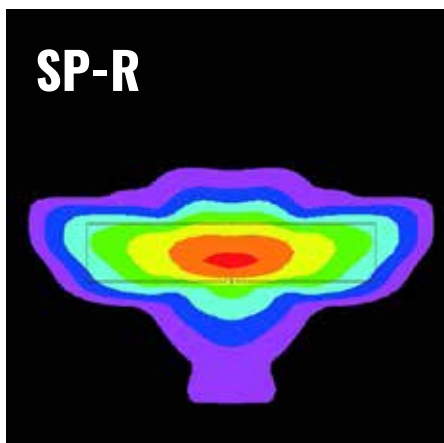

SP-R
Optics for very narrow roads with normal pole spacing. Also an energy efficient option for ramps and such.

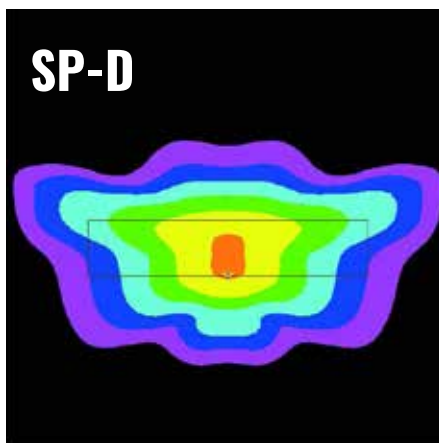

SP-D
For wide roads and long pole spacing. Best installed close to road. Lights also cycleways behind the pole or on opposite side of the road.

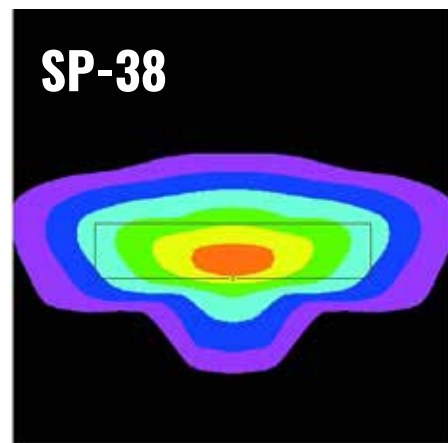

SP-38
Highway optics to be installed on the middle area. Especially suitable for high poles and extra long, up to 100 meter, pole spacing.

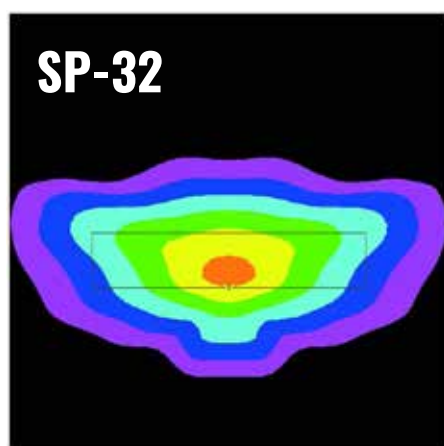

SP-32
Good general optics for both wide and narrow roads and long pole spacing.

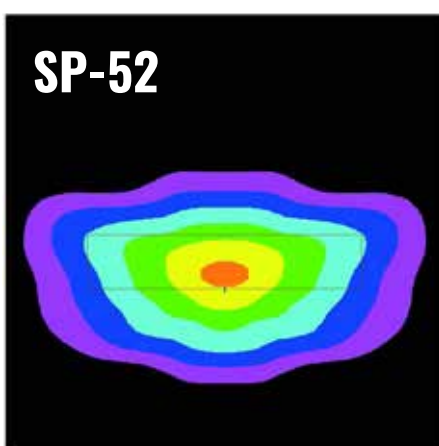

SP-52
General optics for various roads and long pole spacing. Lights also cycleways long behind the pole or on the opposite side of the road.

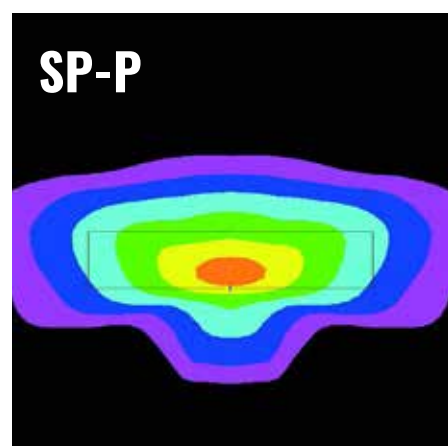

SP-P
Even general optics for lighting both sides of the road or ramps. Suitable for very long pole spacing. Best installed away from the road.

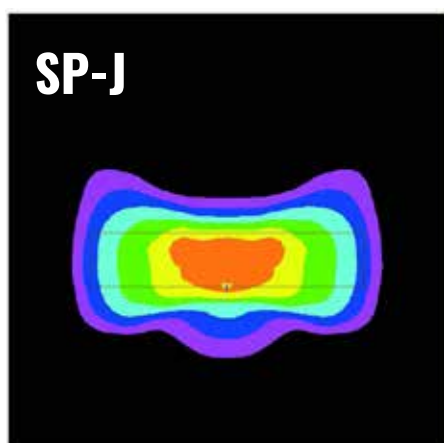

SP-J
Road optics for short pole spacing. Suitable also for parking lot and area lighting.

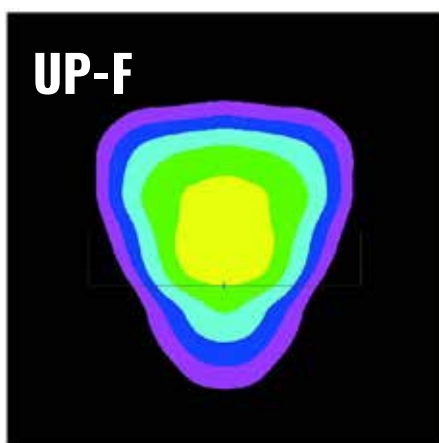

UP-F
Energy efficient and even area lighting optic. A good alternative for floodlights.

ILLUMINANCE (IN LUX, LX)

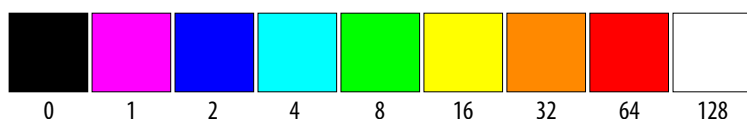

All light patterns depict lights installed at 10 m height and 5° degree angle. Light output 20 000 lm. In light patterns the lights are placed at the edge of a 50 m x 10 m square.

**PRO Flow[®] – cost effective
smart luminaire for street
and area lighting.**





EASY | LED

EASY LED IS THE BRIGHT CHOICE

Investing in high quality LED lighting today will pay off far into the future. Easy LED Oy is a Finnish company specialised in manufacturing of energy efficient LED lighting systems for different uses and environments, such as sports arenas, industrial premises, roads and areas as well as retail and office spaces.

Easy LED Oy
Meriniitynkatu 11
24100 Salo - Finland
p. +358 2 737 44 20
www.easyled.fi

