

SPECIFICATIONS



SPORTS • INDUSTRY • RETAIL • LEISURE • AGRICULTURE

# PRO+ SERIES



EASY|LED



## PRO<sup>+</sup> SERIES

Top quality made in Finland!  
The tried and tested design & structure  
of PRO-series

Versatile and maintenance free

# PRO<sup>+</sup> Series X -technical details

Housing	Anodized aluminium – other surface treatments available in RAL colours, Ceramic coating for entire luminaire available for even improved wear resistance
Optics	Easy LED optimized UV-stabilized PC optics with high impact resistance
Light quality and dimming performance	HD-FF - Flicker Free dimming down to 70 mA and with PWM technology down to 7mA (400 - 500 Hz).
Protection rating	IP66, D-marking and ball impact safe. IK09 available.
Temperature range	Designed for operating temperatures of 290mA: -40°C ...+45°C with thermal protection activation at +50°C (PRO+ 4X has 5°C higher upper limits) or 350mA: -40°C ...+40°C with thermal protection activation at +45°C (PRO+ 4X has 5°C higher upper limits) or 420mA: -40°C ...+30°C with thermal protection activation at +35°C (PRO+ 4X has 5°C higher upper limits) (95 % RH)
Automatic thermal protection	Inbuilt protection with output current dimming and advanced hysteresis
LED unit lumen maintenance L90B10, C10	>200 000 h
Remaining luminous flux after 100 000 h	0,95
Control	Integrated DALI, 1-10V, CLO and Kaamos available. PRO+ X Series available with DMX-RDM control using pre-installed cables (IP66) or Five-pin XLR5 -connectors (IP40 or IP65).
Connection	Preassembled rubber cable (plug available). 2x4-PE QPD-connectors for series installation with M12 for dimming control available
Safety light option	As standard - 175 - 275 VDC
Input voltage	230 VAC (operation voltage range: 198 - 264 VAC)
Input frequency	50/60 Hz
Power Factor (PF) typical	> 0,95
Surge protection:	6 kV L-GND / N-GND, 4 kV L-N
Intelligent inrush current control	As standard
Luminaire protection class	GL I
Installation direction	No limits. (Not to be installed inside insulation to enable cooling)
Luminaire luminous efficacy	Up to 174 lm/W

	CRI >70	CRI >80	CRI >90
5 700K		X	O
5 000K	X	O	
4 000K	X	X	
3 000K	O		

x = standard  
o = option

## Standard opening angles

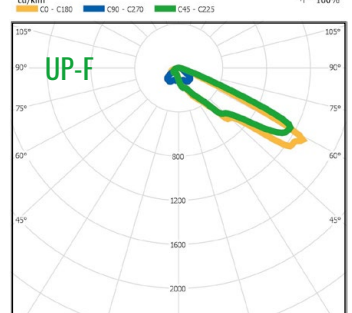
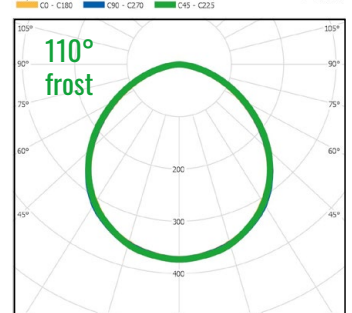
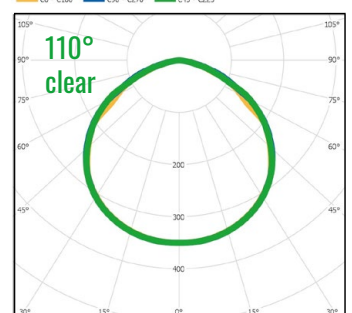
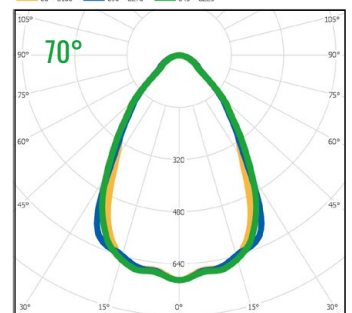
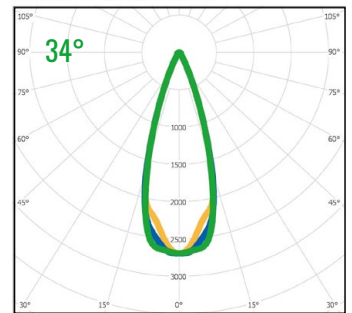
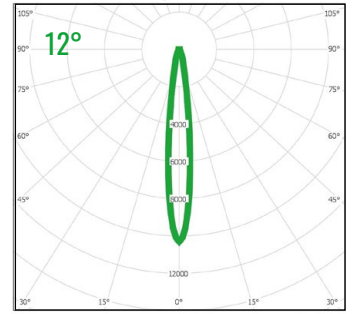

# PRO<sup>+</sup> 4X



LEDs: **120**

Weight: **5,6 kg**

Dimensions (LxWxH): **507 x 230 x 86 mm**

Delivery: **Fully assembled**

Dali addresses: **1**

Inrush current peak: **< 4A (pulses greater than 1ms), 15A, t=170µs, 10% of Ipeak**

Earth leakage current: **0,58 mA**

Maintenance free operating life:  
**100: >100kh at +25°C, 100kh at +40°C, 50kh at +50°C**  
**120: >100kh at +25°C, 100kh at +35°C, 50kh at +45°C**  
**140: >100kh at +25°C, 50kh at +35°C**

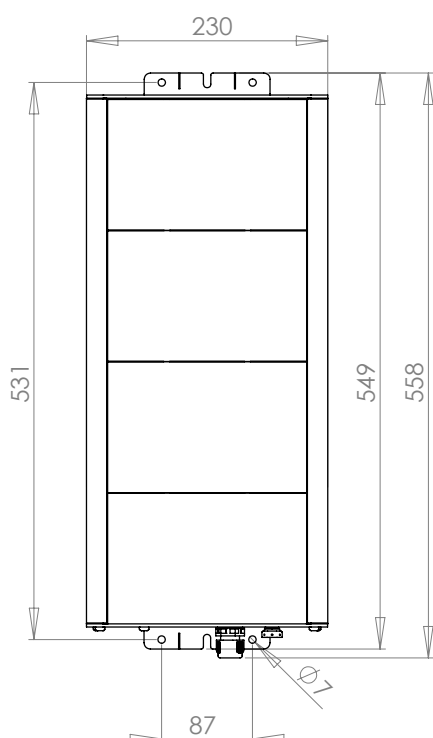

Version	100	120	140
System power [W]	99 W	120 W	146 W
Current [A]	0,45 A	0,55 A	0,67 A
Luminous Flux* [lm]	17 200 lm	20 460 lm	23 790 lm
Luminaire dimming range			
HDFP minimum level	25 %	20 %	18 %
Light minimum level	3 %	2 %	2 %
Power minimum level		4,4 W	

Values shown are nominal values and are subject to +/- 10% tolerance.

\* Luminous flux for 740, dependent on choice of optical solution. For latest values, ask for light distribution files.

# PRO<sup>+</sup> 6X

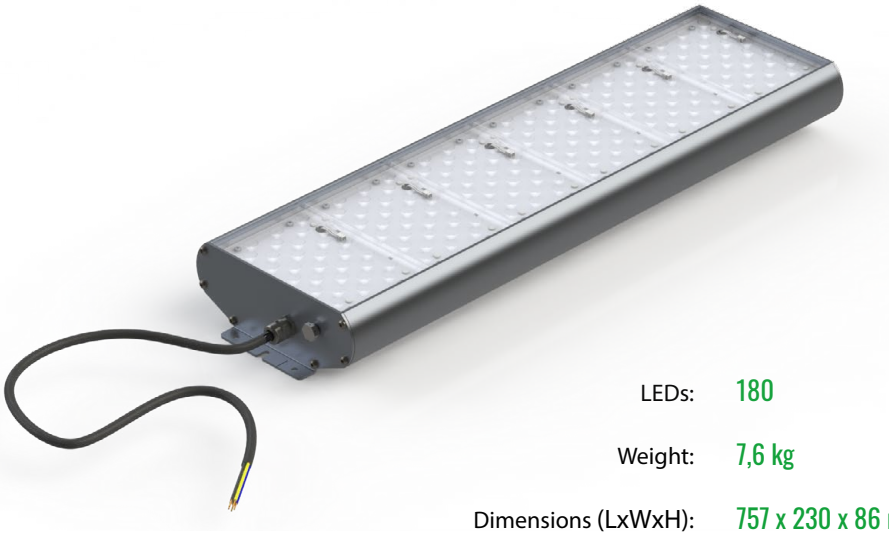

LEDs: **180**

Weight: **7,6 kg**

Dimensions (LxWxH): **757 x 230 x 86 mm**

Delivery: **Fully assembled**

Dali addresses: **1**

Inrush current peak: **< 4A (pulses greater than 1ms), 15A, t=170µs, 10% of Ipeak**

Earth leakage current: **0,61 mA**

Maintenance free operating life: **150: >100kh at +25°C, 100kh at +35°C, 50kh at +45°C  
180: >100kh at +25°C, 100kh at +30°C, 50kh at +40°C  
220: >100kh at +20°C, 70kh at +25°C, 50kh at +30°C**

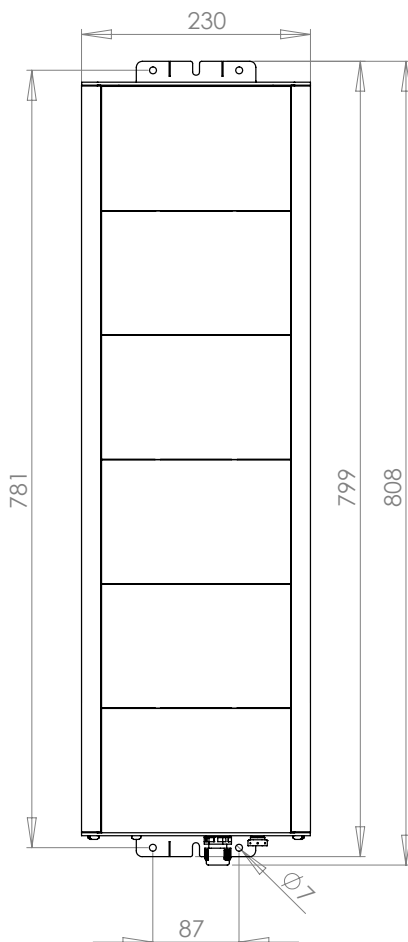

Version	150	180	220
System power [W]	149 W	180 W	218 W
Current [A]	0,68 A	0,82 A	1,00 A
Luminous Flux* [lm]	25 810 lm	30 670 lm	35 550 lm
Luminaire dimming range			
HDF minimum level	25 %	20 %	18 %
Light minimum level	3 %	2 %	2 %
Power minimum level		5,3 W	

Values shown are nominal values and are subject to +/- 10% tolerance.

\* Luminous flux for 740, dependent on choice of optical solution. For latest values, ask for light distribution files.

# PRO<sup>+</sup> 8X



LEDs: 240

Weight: 9,7 kg

Dimensions (LxWxH): 1007 x 230 x 84 mm

Delivery: Without back mounting

Dali addresses: 1

Inrush current peak: < 4A (pulses greater than 1ms), 15A, t=170µs, 10% of Ipeak

Earth leakage current: 0,69 mA

Maintenance free operating life:  
 200: >100kh at +25°C, 100kh at +35°C, 50kh at +45°C  
 240: >100kh at +25°C, 100kh at +30°C, 50kh at +40°C  
 280: >100kh at +20°C, 70kh at +25°C, 50kh at +30°C

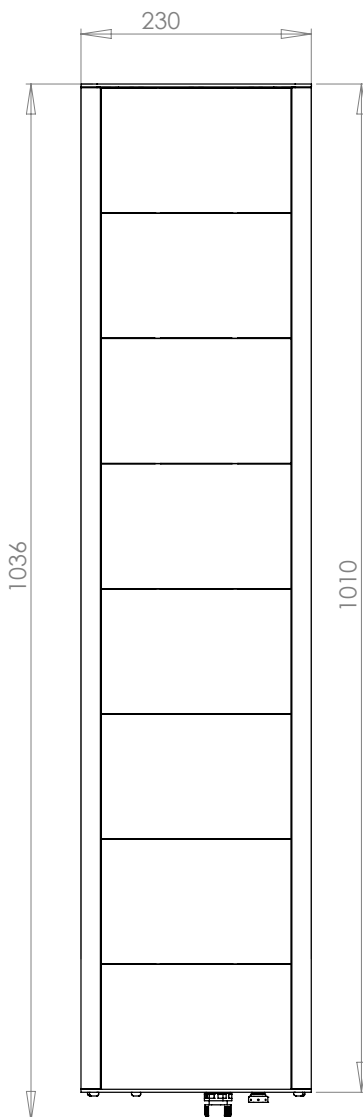

Version	200	240	280
System power [W]	198 W	240 W	286 W
Current [A]	0,91 A	1,10 A	1,31 A
Luminous Flux* [lm]	34 420 lm	40 880 lm	47 290 lm
Luminaire dimming range			
HDFP minimum level	25 %	20 %	18 %
Light minimum level	3 %	2 %	2 %
Power minimum level		6,4 W	

Values shown are nominal values and are subject to +/- 10% tolerance.

\* Luminous flux for 740, dependent on choice of optical solution. For latest values, ask for light distribution files.

# PRO<sup>+</sup> 12X

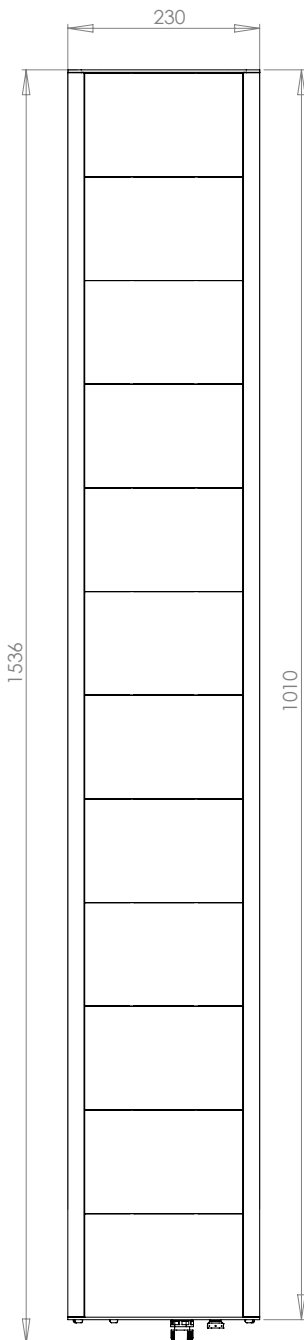

LEDs: **360**

Weight: **14,9 kg**

Dimensions (LxWxH): **1507 x 230 x 84 mm**

Delivery: **Without back mounting**

Dali addresses: **2**

Inrush current peak: **< 8A (pulses greater than 1ms), 30A, t=170µs, 10% of Ipeak**

Earth leakage current: **1,15 mA**

Maintenance free operating life:  
**300: >100kh at +25°C, 100kh at +35°C, 50kh at +45°C**  
**360: >100kh at +25°C, 100kh at +30°C, 50kh at +40°C**  
**430: >100kh at +20°C, 70kh at +25°C, 50kh at +30°C**

Version	300	360	430
System power [W]	298 W	360 W	436 W
Current [A]	1,36 A	1,65 A	2,00 A
Luminous Flux* [lm]	51 600 lm	61 290 lm	70 790 lm
Luminaire dimming range			
HDFP minimum level	25 %	20 %	18 %
Light minimum level	3 %	2 %	2 %
Power minimum level		10,6 W	

Values shown are nominal values and are subject to +/- 10% tolerance.

\* Luminous flux for 740, dependent on choice of optical solution. For latest values, ask for light distribution files.

# PRO+ Series Xi -technical details

Housing	Anodized aluminium. Other surface treatments available in RAL colours, Ceramic coating for entire luminaire available for even improved wear resistance
Optics	Easy LED optimized UV-stabilized PC optics with high impact resistance
Light quality and dimming performance	HDFP - Flicker Free dimming down to 350 mA and with PWM technology down to 50 mA (100 Hz).
Protection rating	IP66, D-marking and Ball impact safe. IK09 available
Temperature range	Designed for ambient temperatures of -40°C ...+50°C (95 % RH), depending on the model
Automatic thermal protection	Inbuilt reversible thermal protection with output current dimming
LED unit lumen maintenance L90B10, C10	>200 000 h
Remaining luminous flux after 100 000 h	0,95
Control	Integrated DALI. CLO, MainsDIM and Kaamos available
Connection	Preassembled rubber cable (plug available). 2x4-PE QPD-connectors for series installation with M12 for dimming control available
Safety light option	186 - 250 VDC as standard (168 - 275 VDC with limited performance)
Input voltage	230 VAC (toiminta-alue: 198 - 264 VAC)
Input frequency	50/60 Hz
Power Factor (PF) typical	> 0,95
Surge protection:	10 kV L-GND / N-GND, 6 kV L-N
Inrush current control	as standard
Luminaire protection class	CL I
Installation direction	No limits. (Not to be installed inside insulation to enable cooling)
Luminaire luminous efficacy	Up to 172 lm/W

	CRI >70	CRI >80	CRI >90
5 700K		X	O
5 000K	X	O	
4 000K	X	X	
3 000K	O		

x = standard  
o = option

## Standard opening angles

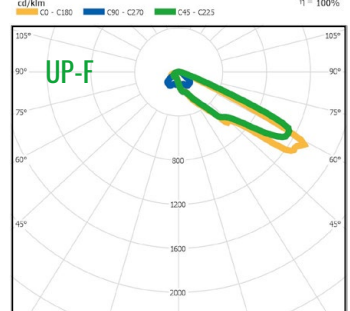
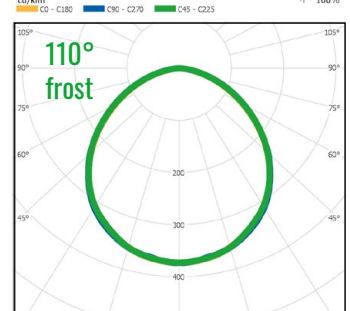
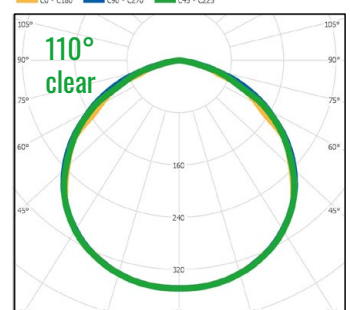
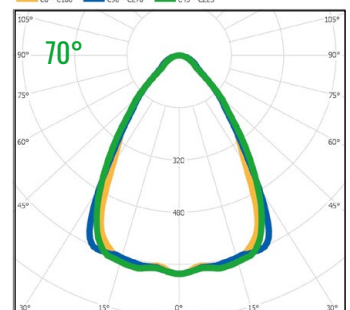
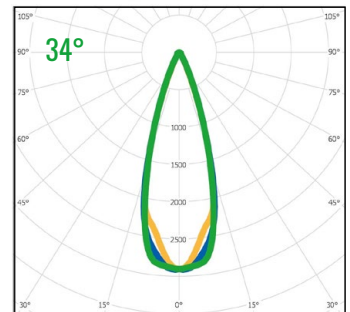
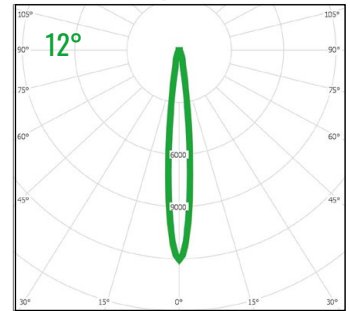



# PRO<sup>+</sup> 4Xi



- LEDs: **88**
- Weight: **6,4 kg**
- Dimensions (LxWxH): **507 x 230 x 86 mm**
- Delivery: **Fully assembled**
- Dali addresses: **1**
- Inrush current peak: **13A, t = 1320µs (50 % of Ipeak)**
- Earth leakage current: **0,22 mA**
- Maintenance free operating life: **100: >100kh at +25°C, 100kh at +40°C, 50kh at +50°C  
120: >100kh at +25°C, 100kh at +35°C, 50kh at +45°C  
140: >100kh at +25°C, 50kh at +35°C**

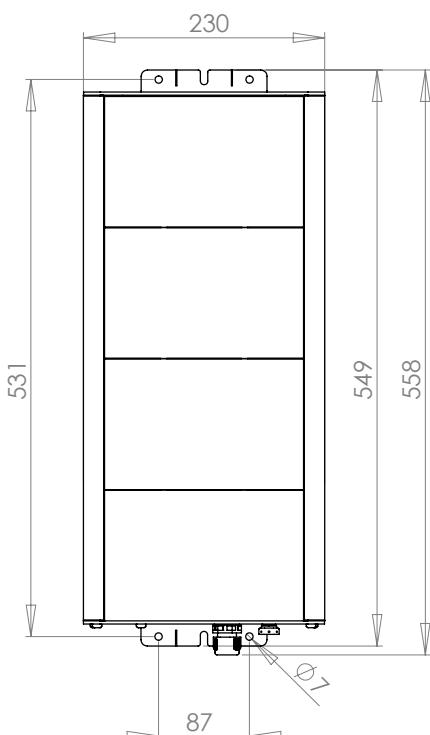

Version	100	120	140
System power [W]	99 W	120 W	146 W
Current [A]	0,5 A	0,6 A	0,7 A
Luminous Flux* [lm]	17 030 lm	19 990 lm	23 220 lm
Luminaire dimming range			
HDFP minimum level	90%	75%	62%
Light minimum level	13 %	11 %	9 %
Power minimum level		18 W	

Values shown are nominal values and are subject to +/- 10% tolerance.

\* Luminous flux for 740, dependent on choice of optical solution. For latest values, ask for light distribution files.

# PRO<sup>+</sup> 6Xi



LEDs: **132**

Weight: **8,4 kg**

Dimensions (LxWxH): **757 x 230 x 86 mm**

Delivery: **Fully assembled**

Dali addresses: **1**

Inrush current peak: **13A, t = 1320µs (50 % of Ipeak)**

Earth leakage current: **0,22 mA**

Maintenance free operating life:  
**150: >100kh at +25°C, 100kh at +35°C, 50kh at +45°C**  
**180: >100kh at +25°C, 100kh at +30°C, 50kh at +40°C**  
**220: >100kh at +20°C, 75kh at +25°C, 50kh at +30°C**

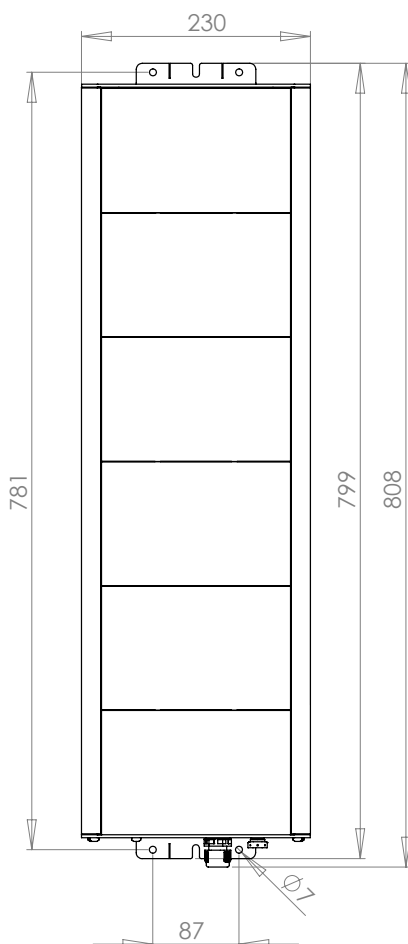

Version	150	180	220
System power [W]	149 W	180 W	218 W
Current [A]	0,7 A	0,8 A	1,0 A
Luminous Flux* [lm]	25 530 lm	29 910 lm	35 070 lm
Luminaire dimming range			
HDFD minimum level	90%	75%	62%
Light minimum level	13 %	11 %	9 %
Power minimum level		23 W	

Values shown are nominal values and are subject to +/- 10% tolerance.

\* Luminous flux for 740, dependent on choice of optical solution. For latest values, ask for light distribution files.

# PRO<sup>+</sup> 8Xi



LEDs: **176**

Weight: **10,5 kg**

Dimensions (LxWxH): **1 007 x 230 x 84 mm**

Delivery: **Without back mounting**

Dali addresses: **1**

Inrush current peak: **13A, t = 1320µs (50 % of Ipeak)**

Earth leakage current: **0,22 mA**

Maintenance free operating life:  
**200: >100kh at +25°C, 100kh at +35°C, 50kh at +45°C**  
**240: >100kh at +25°C, 50kh at +35°C**  
**280: 100kh at +20°C, 70kh at +25°C, 50kh at +30°C**

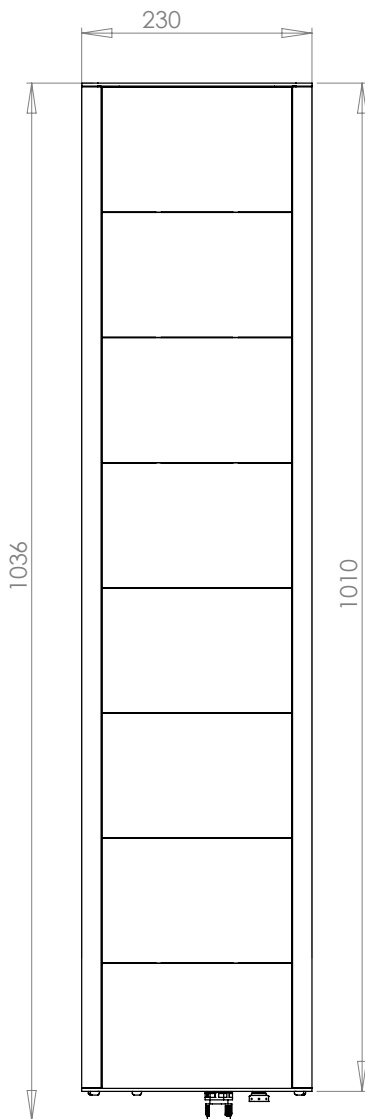

Version	200	240	280
System power [W]	198 W	240 W	286 W
Current [A]	0,9 A	1,1 A	1,3 A
Luminous Flux* [lm]	34 030 lm	39 750 lm	46 600 lm
Luminaire dimming range			
HDF minimum level	90%	75%	62%
Light minimum level	13 %	11 %	9 %
Power minimum level		29 W	

Values shown are nominal values and are subject to +/- 10% tolerance.

\* Luminous flux for 740, dependent on choice of optical solution. For latest values, ask for light distribution files.

# PRO<sup>+</sup> 12Xi

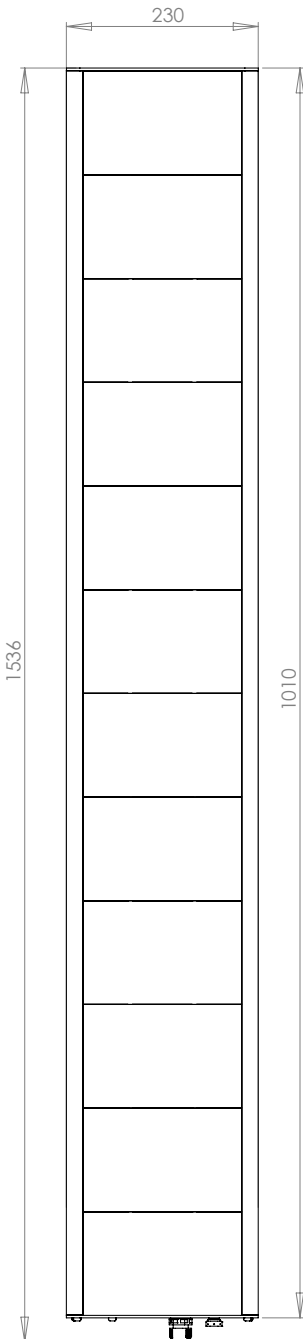

LEDs: **264**

Weight: **16,4 kg**

Dimensions (LxWxH): **1 507 x 230 x 84 mm**

Delivery: **Without back mounting**

Dali addresses: **2**

Inrush current peak: **2 x [13A, t = 1320µs] (50 % of Ipeak)**

Earth leakage current: **0,44 mA**

Maintenance free operating life:  
**300: >100kh at +25°C, 100kh at +35°C, 50kh at +45°C**  
**360: >100kh at +25°C, 100kh at +30°C, 50kh at +40°C**  
**430: >100kh at +20°C, 75kh at +25°C, 50kh at +30°C**

Version	300	360	430
System power [W]	298	360	436
Current [A]	1,4 A	1,6 A	2,0 A
Luminous Flux* [lm]	51 050 lm	59 620 lm	69 830 lm
Luminaire dimming range			
HDFP minimum level	90%	75%	62%
Light minimum level	13 %	11 %	9 %
Power minimum level		46 W	

Values shown are nominal values and are subject to +/- 10% tolerance.

\* Luminous flux for 740, dependent on choice of optical solution. For latest values, ask for light distribution files.



## **PRO<sup>+</sup> SERIES**

More light  
Efficacy up to  
167 lm/W

# PRO<sup>+</sup> Series -technical details

Housing	Anodized aluminium. Other surface treatments available in RAL colours, ceramic coating for entire luminaire available for even improved wear resistance
Optics	Easy LED optimized UV-stabilized PC optics with high impact resistance
Light quality and dimming performance	Linear dimming down to 70 mA
Protection rating	IP66, D-marking and Ball impact safe. IK09 available
Temperature range	Designed for operating temperatures of up to +50°C (95 % RH)
Automatic thermal protection	Inbuilt reversible thermal protection with output current dimming
LED unit lumen maintenance L90B10, C10	>200 000 h
Remaining luminous flux after 100 000 h	0,95
Control	Integrated DALI, CLO, MainsDIM and Kaamos available
Connection	Preassembled rubber cable (plug available). 2x4-PE QPD-connectors for series installation with M12 for dimming control available
Safety light option	Available - 176...276 VDC
Input voltage	230 VAC (operation voltage range 170–264 VAC)
Input frequency	50/60 Hz
Power Factor (PF) typical	> 0,95 (PRO+ 100 <24W: >0,9)
Surge protection:	10 kV L-GND, N-GND (EN 61000-4-5), 6 kV L-N (EN 61547)
Luminaire protection class	CL I
Installation direction	No limits. (Not to be installed inside insulation to enable cooling)
Luminaire luminous efficacy	Up to 167 lm/W

	CRI >70	CRI >80	CRI >90
5 700K		X	O
5 000K	X	O	
4 000K	X	X	
3 000K	O		

x = standard  
o = option

## Standard opening angles

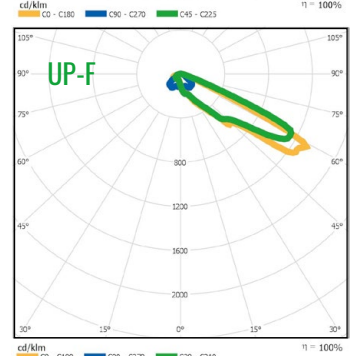
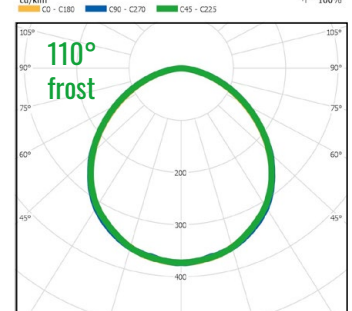
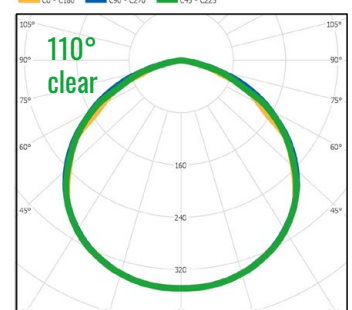
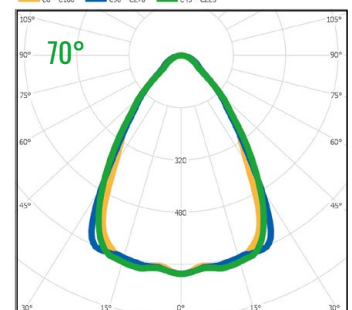
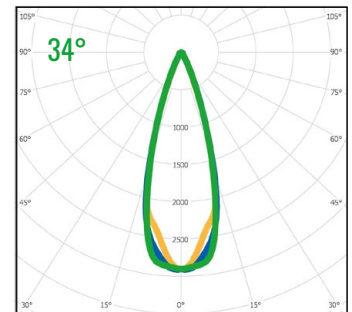
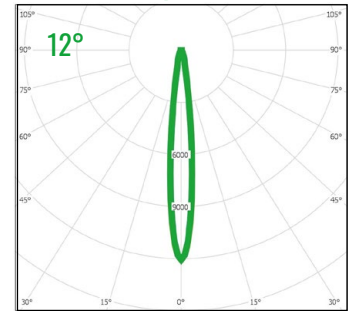

# PRO<sup>+</sup> 100

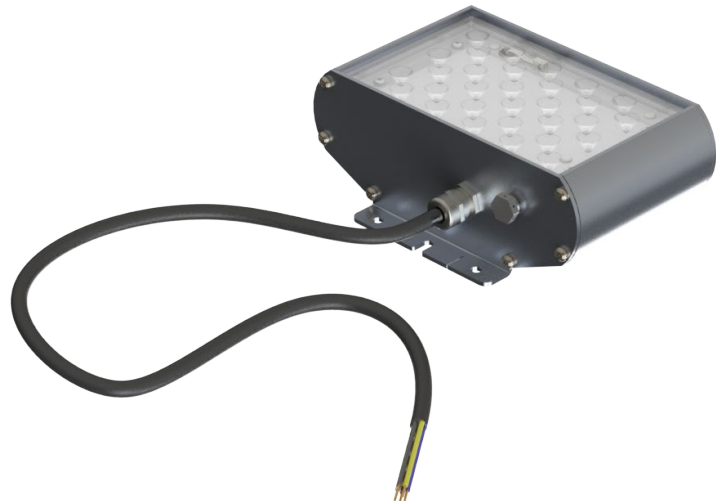

- LEDs: 22
- Weight: 1,9 kg
- Dimensions (LxWxH): 132 x 230 x 86 mm
- Delivery: Fully assembled
- Dali addresses: 1
- Earth leakage current: 0,13 mA
- Temperature range: 200mA & 330mA: -40°C ...+50°C or  
440mA: -40°C ...+45°C or  
600mA: -40°C ...+35°C (95 % RH)
- Maintenance free operating life: 200mA: >100kh at +25°C, >100kh at +45°C, 90kh at +50°C  
330mA: >100kh at +25°C, 95kh at +40°C, 50kh at +50°C  
440mA: >100kh at +25°C, 95kh at +35°C, 50kh at +45°C  
600mA: >100kh at +25°C, 75kh at +30°C, 50kh at +35°C

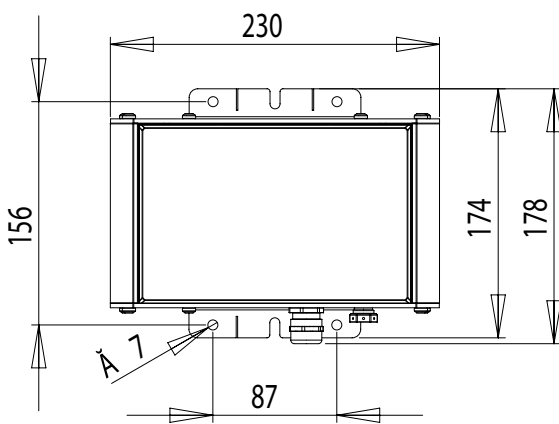

Version	200 mA	330 mA	440 mA	600 mA
System power [W]	15 W	23 W	30 W	41 W
Current [A]	0,08 A	0,11 A	0,14 A	0,19 A
Luminous Flux* [lm]	2 230 lm	3 530 lm	4 540 lm	5 860 lm
Luminaire dimming range				
Light minimum level	34%	22%	17%	13%
Power minimum level		7,2 W		

Values shown are nominal values and are subject to +/- 10 % tolerance.

\*Luminous flux for 740, dependent on choice of optical solution. For latest values, ask for light distribution files.

# PRO<sup>+</sup> 200

- LEDs: 44
- Weight: 3,3 kg
- Dimensions (LxWxH): 257 x 230 x 86 mm
- Delivery: Fully assembled
- Dali addresses: 1
- Earth leakage current: 0,18 mA
  
- Temperature range 380mA: -40°C ...+45°C or  
460mA: -40°C ...+40°C or  
530mA: -40°C ...+35°C (95 % RH)
- Maintenance free operating life: 380mA: >100kh at +25°C, 100kh at +35°C, 50kh at +45°C  
460mA: >100kh at +25°C, 100kh at +30°C, 50kh at +40°C  
530mA: >100kh at +20°C, 85kh at +25°C, 50kh at +35°C

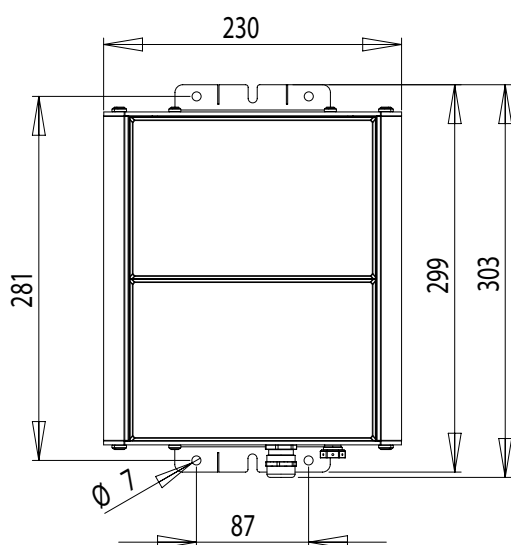

Version	380 mA	460 mA	530 mA
System power [W]	50 W	60 W	68 W
Current [A]	0,24 A	0,28 A	0,32 A
Luminous Flux* [lm]	7 880 lm	9 390 lm	10 750 lm
Luminaire dimming range			
Light minimum level	19 %	16%	14%
Power minimum level		12,7 W	

Values shown are nominal values and are subject to +/- 10 % tolerance.

\*Luminous flux for 740, dependent on choice of optical solution. For latest values, ask for light distribution files.



# PRO<sup>+</sup> 400

LEDs:	66
Weight:	5,0 kg
Dimensions (LxWxH):	382 x 230 x 86 mm
Delivery:	Fully assembled
Dali addresses:	1
Earth leakage current:	0,15 mA
Temperature range:	380mA: -40°C ...+45°C or 460mA: -40°C ...+35°C (95 % RH)
Maintenance free operating life:	380mA: >100kh at +25°C, 100kh at +30°C, 50kh at +45°C 460mA: >100kh at +25°C, 50kh at +35°C

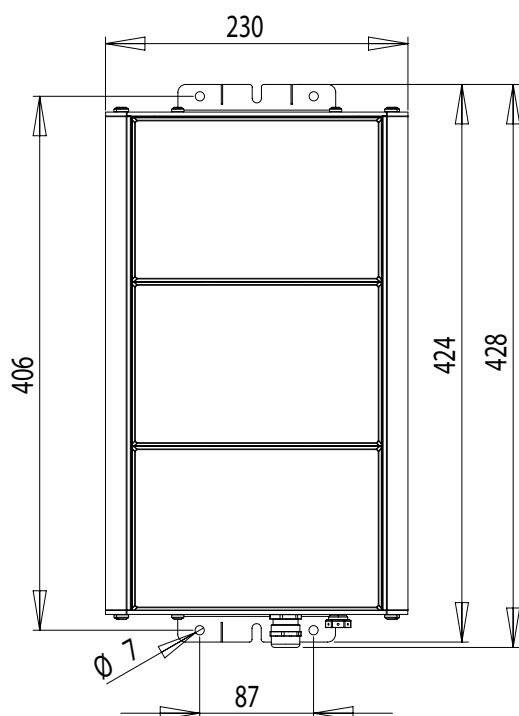

Version	380 mA	460 mA
System power [W]	75 W	90 W
Current [A]	0,35 A	0,41 A
Luminous Flux* [lm]	12 130 lm	14 560 lm
Luminaire dimming range		
Light minimum level	19 %	16%
Power minimum level	16,3 W	

Values shown are nominal values and are subject to +/- 10% tolerance.

\*Luminous flux for 740, dependent on choice of optical solution. For latest values, ask for light distribution files.

# PRO<sup>+</sup> 500

- LEDs: **88**
- Weight: **5,9 kg**
- Dimensions (LxWxH): **507 x 230 x 86 mm**
- Delivery: **Fully assembled**
- Dali addresses: **1**
- Earth leakage current: **0,15 mA**
- Temperature range: **380mA: -40°C ...+40°C or  
460mA: -40°C ...+30°C (95 % RH)**
- Maintenance free operating life: **380mA: >100kh at +25°C, 50kh at +40°C  
460mA: >100kh at +20°C, 75kh at +25°C, 50kh at +30°C**

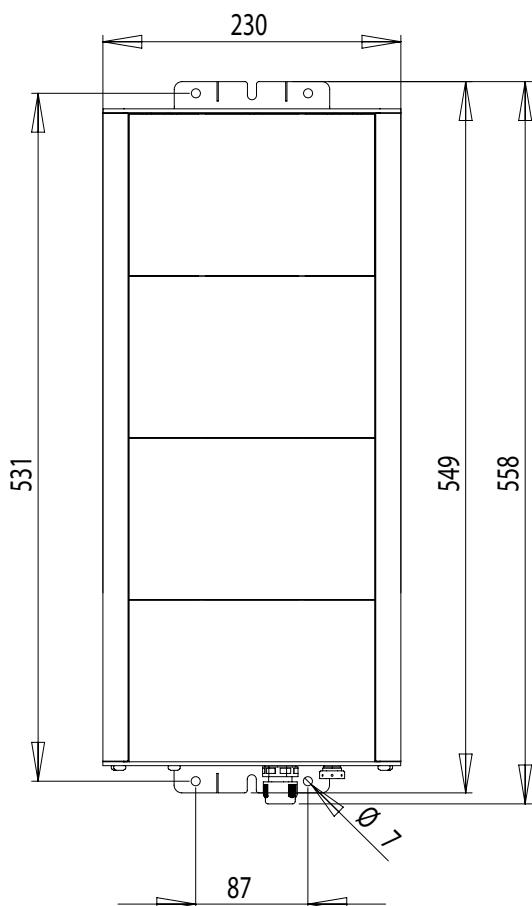

Version	380 mA	460 mA
System power [W]	99 W	120 W
Current [A]	0,45 A	0,54 A
Luminous Flux* [lm]	16 500 lm	19 410 lm
Luminaire dimming range		
Light minimum level	19 %	16%
Power minimum level	21,6 W	

Values shown are nominal values and are subject to +/- 10 % tolerance.

\*Luminous flux for 740, dependent on choice of optical solution. For latest values, ask for light distribution files.



# EASY | LED

## EASY LED THE BRIGHTEST CHOICE

Investing in high quality LED lighting will give you value for now and far in the future. Easy LED Oy is a Finnish company specialized in manufacturing energy efficient LED-lighting for sports, industry, road, area, commercial, retail and office space lighting purposes.

Easy LED Oy  
Meriniitynkatu 11  
24100 Salo - Finland  
p. +358 2 737 44 20  
[www.easyled.fi](http://www.easyled.fi)

