

S P E C I F I C A T I O N S

# Saloa®

INDUSTRY - RETAIL - PARKING GARAGES

EASY LED  
[www.easyled.fi](http://www.easyled.fi)

## Sophisticated Saloa® replaces old fluorescent tubes

The Saloa® from Easy LED Oy is an efficient and economical luminaire to replace the old fluorescent tubing in industry, offices, retail spaces and parking garages. Saloa® is available in several models. With different brackets and fittings the mounting options are versatile.

**Economical** Saloa® lights maintenance free for over 65 000 hours. The high energy efficiency provides savings every day.

**Bright** Saloa® offers even and pleasant light that is easy on the eyes, increases comfort and highlights the colors.

**Durable** Saloa® is built in an aluminum housing. The interchangeable light module with polycarbonate cover makes the luminaire future proof.

# Sophisticated Saloa® replaces 0

Saloa® – Lights the office



Saloa® – Scale drawings

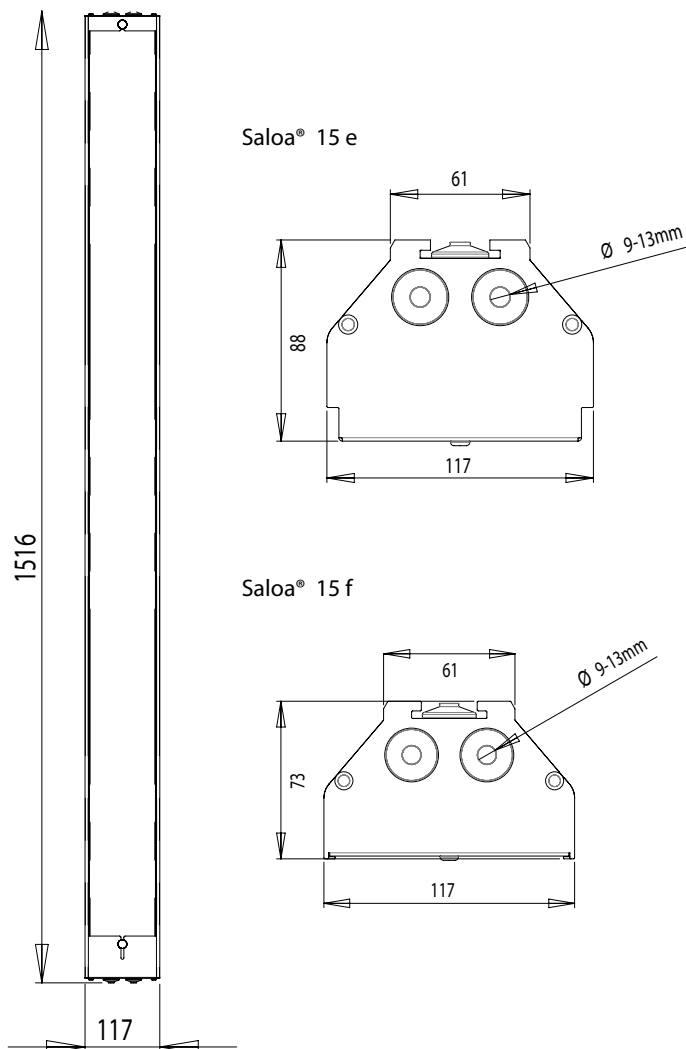

## Saloa® is suitable for every use

Thanks to the bright and even light, the Easy LED Saloa® can be installed where ever fluorescent tubes are used nowadays. The durable construction and long maintenance free life span allow Saloa® to be installed in various environments.

## Economical and durable

Saloa® is built in a through wired white aluminum housing and the light module is protected by a tough polycarbonate cover. The effective but efficient Saloa® has a maintenance free usage life of over 65 000 hours, which makes it economical to use. The light module can be changed by user, making Saloa® also easy to update.

## Different models for different lighting needs

Saloa® has a sleek modern design and fits in any environment. The luminaire is available in a higher e- and a recessed f-models. The higher model casts some light to the sides whereas the flatter lights only downwards.

Light cover comes in two different models: a satin cover providing soft light and a prismatic one that offers as efficient as possible lighting. There are also two power options for the luminaire: 46 W and 78 W.

## Other:

- The luminaire is available in both higher (e) and recessed (f) light unit.
- The light module is easy to replace.
- Polycarbonate light cover, two options:
  - Satin for soft light
  - Prismatic, translucent for efficient light
- Low flicker index guarantees uniform, flicker free light.
- The luminaire is 3 phase through wired (5x2,5 mm<sup>2</sup>), in DALI version also with control.
- Switching points 120 mm from the other and 80 mm from the other end
- Wire holes for 9–13 mm wire on the both ends and back
  - 2 in the middle of the back
  - 2 in both ends
- Mounting directly to the ceiling and most railings with a spring clamp (included)

**The luminaire is delivered fully assembled with light module and ready to be installed**

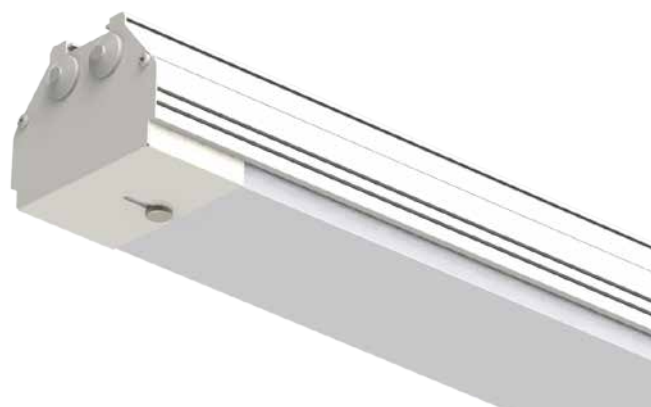

# LED fluorescent tubes

## Saloa® – Light distribution

### Saloa® technical information

Housing:	Extruded aluminum profile, painted white (RAL9010)	
Light cover:	Light cover: Polycarbonate, Satin or Prismatic	
Housing classification:	IP44	
Temperature range:	Designed for ambient temperatures from -20°C...+40°C (L15-models) -20°C...+50°C (S15-models)	
Maintenance free luminaire usage life:	L90B50 30 000 h L80B50 65 000 h	
Control:	DALI control option available.	
Input voltage:	230 VAC (198 - 264 VAC) (190 - 280 VDC)	
Input frequency:	50/60 Hz	
Power Factor (PF) typical:	>0,95	
System power [W]:	L15 models 78 W S15 models 46 W	
Current [A]:	0,35 A (230 VAC)	
Luminous flux [lm]:	Satin	Prismatic
	Saloa L15 e 9 500 lm	10 210 lm
	Saloa L15 f 8 670 lm	9 330 lm
	Saloa S15 e 5 320 lm	5 690 lm
	Saloa S15 f 4 900 lm	5 160 lm
Standard light color:	4000 K	
Color Rendering index (CRI):	>80 R <sub>a</sub>	
Luminaire luminous efficacy typical*	Satin	Prismatic
	Saloa L15 e 122 lm/W	131 lm/W
	Saloa L15 f 111 lm/W	120 lm/W
	Saloa S15 e 116 lm/W	124 lm/W
	Saloa S15 f 107 lm/W	112 lm/W
Flicker Index:	< 0.01 @ < 5 kHz	
Weight:	4,4 - 4,6 kg (depending on the model)	
Dimensions (LxWxH):	1520 x 117 x 88 mm (Saloa L15/S15 e) 1520 x 117 x 74 mm (Saloa L15/S15 f)	
Standard installation height:	3 - 7 m	
Guarantee:	5 years	

The new improved light module with output of up to 150 lm/W!

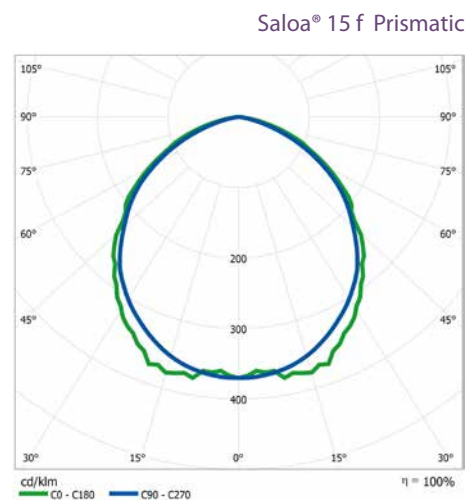
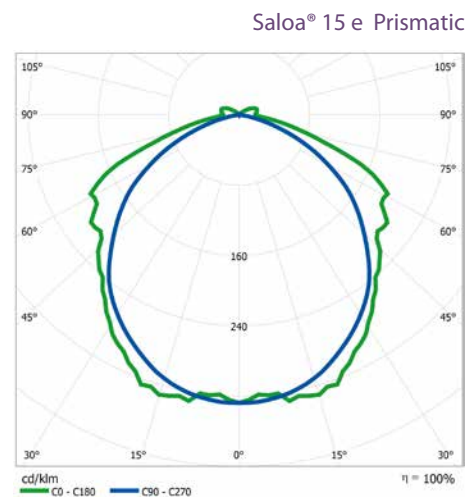
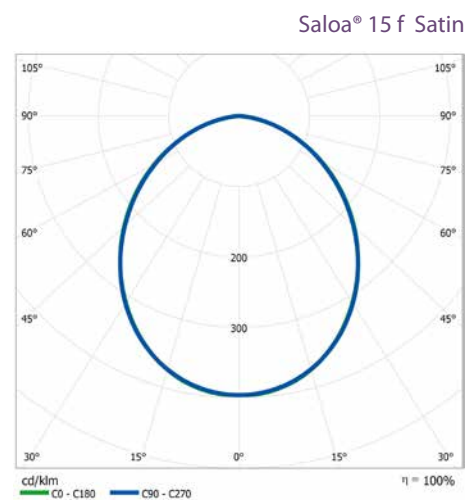
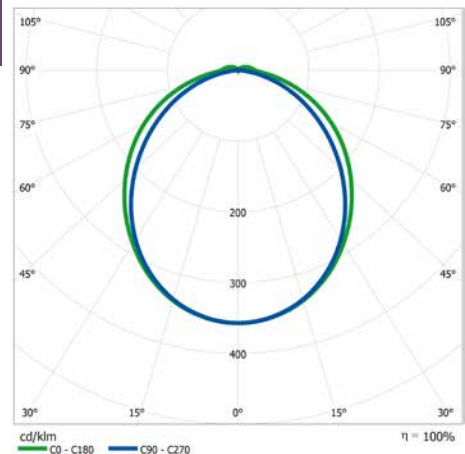

\*Values shown are nominal values and are subject to +/- 10% tolerance. For latest values, ask for light distribution files.

### Product codes

1003119 Saloa L15 e Satin	1003081 Saloa S15 e Satin
1003120 Saloa L15 e Prismatic	1003082 Saloa S15 e Prismatic
1003121 Saloa L15 f Satin	1003085 Saloa S15 f Satin
1003122 Saloa L15 f Prismatic	1003086 Saloa S15 f Prismatic
1003079 Saloa L15 e Satin DALI	1003098 Saloa S15 e Satin DALI
1003080 Saloa L15 e Prismatic DALI	1003099 Saloa S15 e Prismatic DALI
1003083 Saloa L15 f Satin DALI	1003100 Saloa S15 f Satin DALI
1003084 Saloa L15 f Prismatic DALI	1003101 Saloa S15 f Prismatic DALI

## Versatile mounting options

Saloa® luminaires can be mounted directly to ceilings or rails with the **included standard fittings** or almost anywhere with versatile optional fittings and brackets.

The different fittings and brackets sold separately enable various types of installations, for example hanging mounting to ceiling or adjustable installation to wall, ceiling or rail with special fittings. A side-by-side rail fitting is also available for twin

installation of two luminaires. All Easy LED fittings are made of stainless steel and can be painted according to order.

The luminaires are through wired and they can be attached together with a special fastener. The replacing of the old T5/T8 fluorescent tube luminaires can be often done using the existing wiring.

## Fittings (optional)

Ramp mounting 3045 (for railwidth 3–4,5 m)

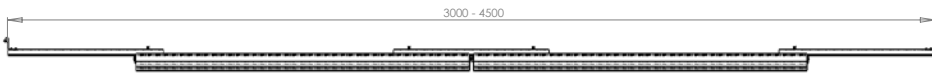

Ramp mounting 2440 (for railwidth 2,4–4 m)

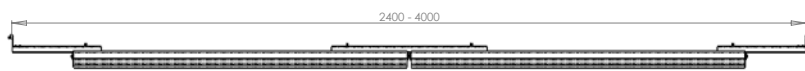

Ramp mounting 3140 (for railwidth 3,1–4 m)

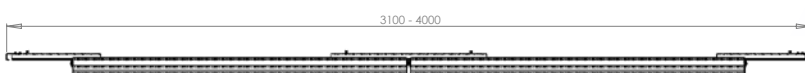

Pendant mounting, installed to the groove on the back of the luminaire, suitable for hanging hook mounting.

Adjustable mounting, for roof, rail and wall mounting. The mounting allows directing of the light.

Parallel mounting kit for installing two Saloa® luminaires, ceiling or rail mounting.

Parallel mounting kit 22,5° for installing two Saloa® luminaires, direction of the light can be adjusted.

Surface mounting for fixed wall or track mounting.

Saloa® 15 e / standard fitting

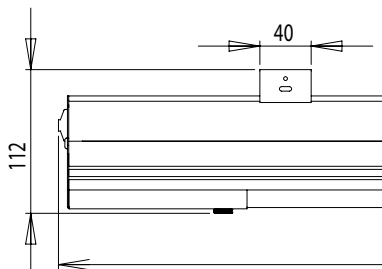

Saloa® 15 f / standard fitting

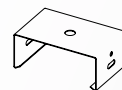
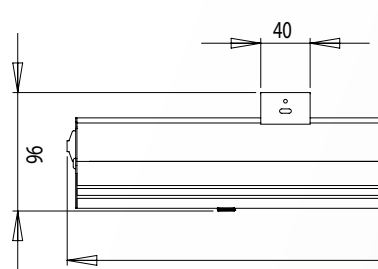

# EASY LED

Easy LED Oy  
Meriniitynkatu 11  
24100 Salo - Finland  
p. +358 2 737 4420

[easyled.fi](http://easyled.fi)